

Linear and Rotary Solenoids



The leader in solenoid solutions from the first choice in motion innovation

Johnson Electric's Industry Products Group (IPG) provides motion products and customized solutions for a broad range of commercial and industrial applications. As a member of this group, Ledex® is the world's leading industrial solenoid brand. We invented the first rotary solenoid more than 60 years ago, and we have been a technology pioneer ever since. Our hallmark is developing electromechanical and electromagnetic solutions for the most challenging applications.

Our experienced team of design and production engineers solve complex problems for a diverse spectrum of applications ranging from printers to defibrillators, weapon systems to ATMs, door locks to wastewater pump controls, and switchgear devices to food and beverage controls.

No matter what your specific actuation project involves, we are confident that we can deliver the solution. We couple excellent customer service and delivery performance with our technical design advantage to provide you with a premium service experience in all aspects of your relationship with us. We look forward to working with you.



Johnson Electric: The safe choice for motion innovation...

Johnson Electric offers the products and capacity to reach your global needs. Our motion solutions are in thousands of applications globally. For example:

- 1 out of 4 coffee grinders is powered by Johnson Electric
- 2 out of 5 vacuum cleaners run on a Johnson Electric motor
- 3 out of 4 postal sorters in America have a Johnson Electric motion solution
- 4 out of 5 ink jet printers have a Johnson Electric motion system
- 2 out of 5 cars have features powered by many products from Johnson Electric
- 2 out of 5 hair dryers run on a Johnson Electric motor, 4 out of 5 in America
- 1 out of 4 drills runs on a Johnson Electric motor
- 1 out of 3 digital cameras incorporates a motion subsystem by Johnson Electric
- 1 out of 4 garden tools is powered by a Johnson Electric motor

Johnson Electric offers a comprehensive combination of technology, engineering and manufacturing motion solution resources. Our products are designed, built, tested, packaged, and shipped to exacting specifications.

We strive to be the most reliable business partner for our customers; we are responsive and flexible, and have the financial stability and organizational integrity to meet all our commitments and to support our customer's success.

Looking for a competitive advantage?

Product reliability and assurance of supply are our commitment. Our family of motion products and subsystems is comprised of stepper motors, DC motors, switches, solenoids, flexible circuits, motion control, precision plastics and precision gears.

Johnson Electric offers the capacity that counts

- 3 million motors & actuators/day
- 15 million switches/month
- 40,000 employees and subcontract workers in 20 countries

Our business growth is driven by our industry leading brand motion products, such as Ledex® solenoids, that deliver differentiation and innovation to our customers. The core platform for delivering these solutions is a highly developed production base and focused customer support teams throughout the world. This combines scale advantages in production and procurement with skilled and dedicated motion application experts.

Why select a Ledex® Solenoid?

Applications/Selection

Page 4 – 9

Rotary Solenoid Products

Page 10 – 21

Linear Solenoid Products

Page 22 – 33

Engineered Solutions/Custom Assembly Designs

Page 34 – 35

Actuation for machine and process automation must range from the most basic on-off function to extremely complex sequencing. When the process involves linear or rotary motion, solenoids are among the best actuation devices in terms of size, cost, simplified installation and ease-of-use.

On the following pages, we've shown several application examples that demonstrate the wide range of markets and applications to which our solenoid products are applied.

In keeping with recent industry trends, we have developed many solenoid designs to be especially advantageous for specific application demands including:

- **Saving Energy** with magnetic latching solenoids for power off engagement
- **Quiet** operation
- **Miniature** size for space-restricted applications
- **Long-life** designs for extremely consistent and dependable operation
- **High speed** designs for maximum throughput and productivity

Whether your design includes linear or rotary actuation, we can help you determine the best solenoid to meet your application design requirements, such as:

Exceptional Force/Torque

A linear solenoid can provide up to 30 pounds of force from a unit less than 2-1/4 inches long. A rotary solenoid can provide well over 100 lb-in of torque from a unit also less than 2-1/4 inches long.

Compact Size

Need low profile? Minimum volume? Ledex solenoids can pack more work per cubic inch than motors. Many of our new miniature series units are in the 1/2 to 1" size.

Simplified Control

Being a pulsed device with minimal components optimizes solenoids for digital control. This results in faster cycling and higher reliability with fewer interfaces.

Uncompromising Reliability

Ledex solenoids provide repeatable, predictable performance with a specified life of up to 100 million cycles.

Primary solenoid operational functions

Divert

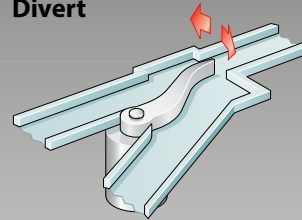

Gate diverters, depending on the application, can be used continuously or very infrequently. In this example, a BTA rotary actuator is chosen for its field-proven long life rating of 100+ million actuations.

Lock/Latch

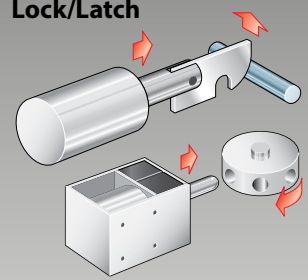

Low cost, compact size, reliability and long life are all reasons for the growing demand for Ledex solenoids in a wide variety of locking applications including vault doors, cash registers, disk drives and missile systems.

Kick

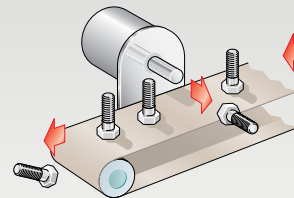

Immediate, snap-acting response and electric operation are inherent solenoid attributes that are ideal for interfacing with motion electronics and detection sensors for part rejection processes.

Whether rotary or linear, a Ledex solenoid is easily configured into machine designs requiring a platform or stage to be latched in position during a particular machine process.

Pinch

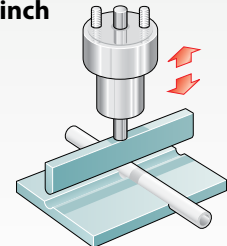

Tubes carrying body fluids on many medical systems must have accurate control of flow regulation. In this example, a Soft Shift linear solenoid is chosen for its variable positioning capability to smoothly pinch the tube to the operator's precise demand. Using a solenoid in this manner eliminates valves and other connecting apparatus which pose a potential threat for contamination or leakage.

Position

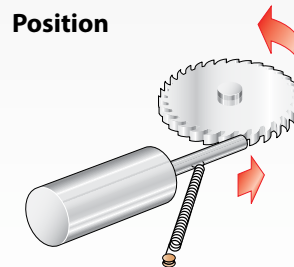

Positioning applications can range from a simple ratcheting device, such as the one illustrated, to precise variable positioning sub-assemblies using linear Soft Shift solenoids or rotary BTA actuators.

Where to use Ledex® Solenoids: Application Examples

Commercial Automation

Ledex® solenoids and subassemblies are ideal for today's automation functions in banking and commerce. Our products are currently utilized in numerous banking facility and automated commercial operations including:

Mail Processing

- High speed flat sorters
- Parcel sorters
- Envelope preparation
- Accumulators
- Diverters
- Stamping/metering
- Mixed mail variety sorting
- Drive belt tensioning
- Bar code sorters
- Zip code specific diverter gates
- Mail tray horizontal stack pusher
- Optical recognition character reader/sorter
- Conveyor systems
- Lights out/unmanned bulk mail sort system
- Automated tray management systems
- Rail and tilt cars
- Mail bucket lever trip mechanisms



Commercial Automation

- ATM security - money compartment and door locks
- Cash drawer locks
- Check processing
- Bill straightening, validating, sorting by denomination, stacking
- Coin management
- Coin changers
- Currency counters



Printers/Copiers

- Envelope conditioning
- Automated receipt/ticket paper feed and cut-off
- Printing/copier functions including folding, inserting, collating, cutting, counting

Vending

- Product dispensing
- Money return
- Machine locks

Projectors

- Shutters



Material Handling

Our extensive line of linear and rotary solenoids are a predominant solution for all forms of material handling applications. Rotary solenoids, in particular, are used extensively for sorting and diverting operations. When sorting by weight, dimension and color including video inspection, solenoids kick out and divert product into appropriate bins, shipping or storage containers. Common examples of our current material handling installations include:

Packaging Machinery

- Product selection
- Product dispensing
- Conveying
- Wrapping
- Diverting

Document Processing

- High speed sorting
- Folding
- Inserting
- Diverting

Food and Beverage Processing

- High speed sorting
- Diverting
- Dispensing
- Bottle capping
- Video inspection



Where to use Ledex® Solenoids: Application Examples

Medical and Pharmaceutical Equipment

The quality and reliability of Ledex® solenoids make them the ideal solution for medical automation, pharmaceutical manufacturing and surgical equipment. Our advancements in miniaturization, quiet operation and long life designs are particularly valuable for applications such as these where dependable, accurate performance is paramount.

Other solenoid functional attributes that are beneficial to these markets include:

- Precise, clean, quiet, reliable automation of medical equipment functions
- Compact size with high force or torque
- Easy control with simple electronics
- Instant actuation or smooth variable positioning
- High MTBF, reliable, repeatable operation without degradation due to wear
- Long life
- Open loop or closed loop microprocessor controlled systems

Specific solenoid applications include:

Pharmaceutical

- Medication compartment locks
- Medication cabinet locks
- Automated tablet counter
- Automated tablet diverter

Diagnostics

- Reagent dispensers
- Cuvette diverters
- X-ray processing
- Fluid analysis

Treatment

Surgical

- Intra-ocular microsurgery
- Surgical lasers
- Auto transfusion
- Instrument sterilizers
- IV fluid metering



Circuit Breakers and Switchgear

Ledex® solenoids are the ideal actuator technology for opening and closing electrical contacts on circuit breakers, electrical meters and other switchgear devices due to their high speed actuation, compact size, high force, high reliability and simple control. Most typical applications use magnetic latching solenoids and spring returned solenoids, which manually reset and electrically unlatch or trip.

The speed of solenoids minimizes arcing and potential personal injury due to electrical shock. And, their high holding forces increase contact pressure that results in extended operational life.

Specific solenoid applications include:

- Remote disconnects and reclosers
- Heavy duty industrial breakers
- Molded case breakers
- Residential single and double pole breakers
- Oil or vacuum filled high voltage re-closers
- Residential electric meters
- High voltage utility pole transmission lines where it is desirable to selectively connect or disconnect power, without human intervention on site
- Under Voltage Release (UVR)
- Indicator using a miniature bistable solenoid to indicate an abnormal situation, in the presence of extremely low tripping energy, high shock and vibration and a wide temperature range.

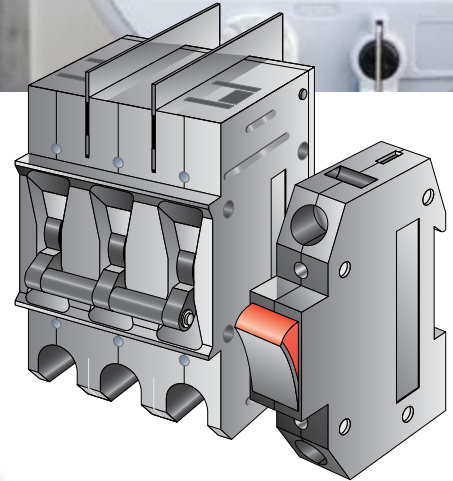

Solenoids are used for residential as well as heavy duty industrial breakers

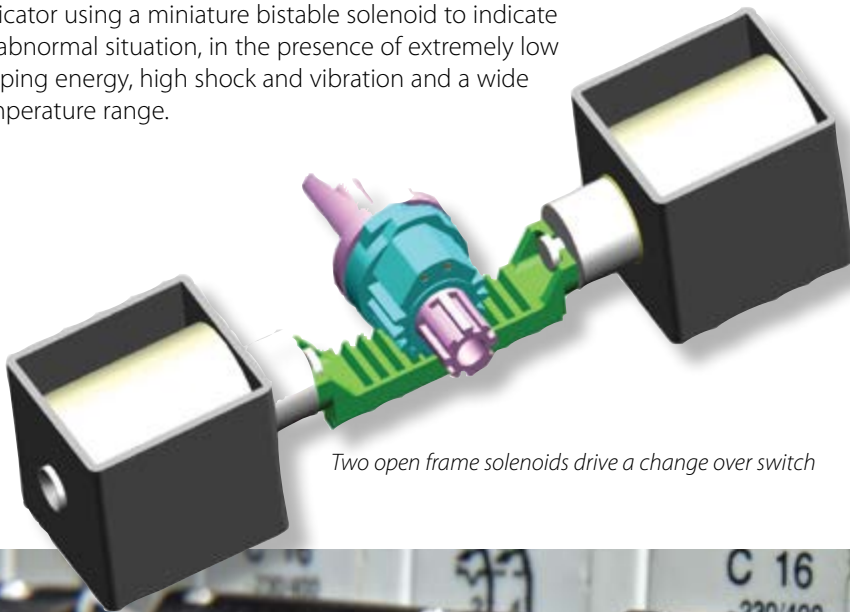

Two open frame solenoids drive a change over switch



Where to use Ledex® Solenoids: Application Examples

Security and Locking

Ledex® solenoids have a lock on security technology. For decades, our solenoids have been used on a broad range of indoor and outdoor applications that require a locking device. Whether it is a door or gate lock, medical instrument lockout function, or an industrial application, solenoids provide an effective, reliable locking mechanism.

Specific solenoid applications include:

Building Automation

- Hotel room door locks
- Safe locks
- Prison locks
- Fire door safety closures
- Public and private parking gates
- Overhead door locks

Medical

- Drug cart locks
- Drug compartment locks
- Sterilizer locks
- Centrifuge locks
- Analysis machine locks
- Surgical tray locks

Industrial

- Machine tool locks
- Metrology locks
- Fork lift safety lockouts
- Inventory storage locks
- Test chamber locks



Ledex® solenoids are time-tested, field-proven in a widely diverse range of industrial and commercial applications . . . Put our experience to work for you.

Call our application engineers at 937.454.2345 to discuss your application requirements.

Or click on the link button for more information on other Ledex applications.



Emerging Trends in Solenoid Actuation

Ledex® Solenoid Products are most often created to address the specific critical performance requirements set by today's design engineers.

With our diverse range of linear and rotary solenoids, and our commitment to innovative technology developments, our products are aligned to meet the most challenging new product design objectives.

Following are highlights of primary design trends that focus on our customers' leading edge commercial and industrial applications.

Long Life

Many Ledex solenoid platforms offer extended operational life that reduce down time and service costs. Our newest long life platform includes an order of magnitude improvement (1 to 5 million cycles) for select DC Open Frame solenoids.

Life (millions of cycles)

	Life (millions of cycles)	
Rotary	BTA	100
	Ultimag	100
	Rotary Solenoids	1
	Long Life Rotary Solenoids	50
Linear	STA Tubular	25
	Soft Shift	10
	Low Profile	1
	Open Frame	0.1 – 0.5

Energy Efficiency

Green design initiatives require energy savings at an increasing rate. Ledex magnetic latching linear solenoids can be used for low duty cycle applications in which the solenoid's "on" position is held indefinitely with no power consumption.

While continuous duty, on/off solenoids tend to develop heat, magnetic latching solenoids do not since no power is consumed in the energized state.

Since magnetic latching solenoids are typically used in low duty cycle applications, they are also perfect candidates for battery operation with as little as 3 to 6 volts.

Typical applications for magnetic latching solenoids include door closers, locks, latches and security devices. Almost any solenoid type can be developed as a magnetic latching version. We offer tubular and open frame magnetic latching solenoids platforms as standard. Custom designs are developed on a regular basis for specific application requirements.



Battery Operation

Remote operation of actuation devices is easily accomplished with battery operated solenoids. We offer many choices of battery operated Ledex® solenoids that provide a full range of specific design benefits.

Our application engineers can help you determine which battery is right for your design needs using our proprietary battery calculator software. Please contact us to discuss your application requirements.

High Speed Actuation

Automation applications demand increasing rates of operation for improved throughput and cost competitiveness. Solenoids are inherently high speed actuation devices and our product development initiatives continue to push the envelope on this important design parameter.

Speed (msec) – Typical

	Speed (msec)	
Rotary	BTA	10
	Ultimag	3
	Rotary Solenoids	7
	STA Tubular	10
Linear	Soft Shift	8
	Low Profile	10
	Open Frame	10

Quiet Operation

The need for increasingly quiet performance is a major focus in today's products. The Ledex Brand of Johnson Electric has developed a new family of rotary and linear actuation devices that offer significant sound reduction advantages over conventional solenoid products.

For example, our standard STA tubular solenoid performs in the 80-98 dBA range. While this is perfectly acceptable for most applications, a dampened sound or a quiet technology may be required where noise reduction is beneficial. To address this need, we have launched two new STA platforms.

Our new STA-D quiet tubular solenoids employ innovative technology that reduces the traditional impact at the end of the stroke, while maintaining high hold force. As a result, the STA-D provides a 20 dBA sound reduction.

For applications requiring even quieter performance, our new STA-Q quiet solenoids offer the ultimate in sound reduction through the elimination of the traditional end-of-travel hard stops. When energized, the STA-Q provides a 40 dBA noise reduction. The STA-Q has a reduced holding force that is ideal for applications where impacting forces are considered a negative characteristic, and where the application load will maintain its own position.

Our Soft Shift products are inherently quiet as well and can provide velocity controlled positioning if desired.



Open Design Engineered Products

Ledex® has a number of open design, adaptive product platforms that are readily tailored to our customers' specific needs. In an increasingly competitive global market that demands leading edge technology and rapid deployment to market, our open design products are often the perfect solution.

See page 34 for details





	MagShift	PMA	CamBolt
Quiet Actuation	■	■	■
Long Stroke		■	
Magnetic Latching		■	
Mechanical Latching			■
Shock Resistance			■
Bidirectional Actuation		■	■
Medium to High Force	■	■	

Rotary Solenoid Functional Comparison At-a-Glance

From the chart below, choose the solenoid design with characteristics best suited to your application requirements, then refer to the following pages for more detailed information by series and by model.

Follow the links to our website for complete performance ratings, technical data, and mechanical specifications.

			
	BTA® Actuators	Ultimag® Actuators	Rotary Solenoids
Stroke	Up to 45°; CW or CCW	Up to ±22-1/2° (from a 0° de-energized starting position)	Up to 110°; CW or CCW
Functional Attribute: Battery Powered — High Speed — Long Life — Miniature Size —	• • •	• •	• • • •
Max Power Output (Torque or Force)	12.9 lb-in (1.5 Nm)	14 lb-in (1.58 Nm)	Up to 46.6 lb-in (5265 mNm)
Power Consumption	Average	Average	Average
Duty Cycle	Continuous or intermittent	Continuous or intermittent	Continuous or intermittent
Housing Style (with a variety of options for: Shaft Ends — Mounting Styles — Power Termination — Imperial and Metric —	Completely enclosed • • • •	Completely enclosed • • • •	Compact design • • • •
Operational Characteristics	<ul style="list-style-type: none"> • High speed cycle rate • Can provide closed loop velocity and position control • Quiet, shock-free operation • True rotary motion with no axial displacement 	<ul style="list-style-type: none"> • Fast energizing time • Extremely high speed cycle rates • On/off or proportional mode operation • Quiet, shock-free operation • True rotary motion with no axial displacement 	<ul style="list-style-type: none"> • High torque to size ratio • On/off operation • “Snap” acting • Some axial displacement necessary
Life (millions of cycles)	100	100	1 (standard); 50 (extended life)
Size	5 sizes: <ul style="list-style-type: none"> • Diameters from 1-1/8" to 2-3/8" (30 to 59 mm) • Lengths from 3/4" to 1-5/8" (18 to 41 mm) long 	3 sizes: <ul style="list-style-type: none"> • Diameters from 1-5/8" to 2-3/8" (41 to 59) • Lengths from 1" to 1 5/8" (26 to 41 mm) long 	9 sizes: <ul style="list-style-type: none"> • Diameters from 1" to 2-3/4" (25 to 70 mm) • Lengths from 5/8" to 1-3/4" (16 to 45 mm)

Overview Comparison by Model



BTA® Actuators

Model	2EV ●◆★	3EV ◆★	4EV ◆★	5EV ◆★	6EV ◆★
Dimensions (in)	Ø1.188 x 0.719	Ø1.375 x 0.89	Ø1.625 x 1.055	Ø1.937 x 1.265	Ø2.312 x 1.625
Stroke	45°	45°	45°	45°	45°
Gross Starting Torque (lb-in)	1.00	1.66	1.85	6.00	12.90
Power (W)	20 – 100	13 – 130	14.5 – 145	21 – 210	32 – 320
Supply (V)	3.1 – 80	1.9 – 78.7	3.2 – 115	4.7 – 168	9.2 – 313

Ultimag® Actuators

Model	4EM ◆★	5EM ◆★	6EM ◆★
Dimensions (in)	Ø1.625 x 1.04	Ø1.937 x 1.31	Ø2.312 x 1.6
Stroke	±22.5°	±22.5°	±22.5°
Net Starting Torque (lb-in)	2.8	6.3	14
Speed (Hz)	>78	>67	>12.8
Power (W)	14.5 – 145	42 – 210	32 – 320
Supply (V)	3.2 – 115	6.6 – 168	9.2 – 313



Ledex® Rotary Solenoids

Model	1E ●◆★◆	2E ●◆★	3B ◆★	3E ◆★
Dimensions (in)	Ø1.000 x 0.625	Ø1.125 x 0.656	Ø1.312 x 0.875	Ø1.312 x 0.797
Stroke	Up to 45°	Up to 45°	Up to 67.5°	Up to 67.5°
Starting Torque (lb-in)	Up to 1.1	Up to 1.7	Up to 3.2	Up to 3.2
Holding Torque (lb-in)	Up to 0.3	Up to 0.5	Up to 0.9	Up to 0.9
Power (W)	10.5 – 108	7 – 140	10 – 200	9 – 180
Supply (V)	2.9 – 94	2.2 – 128	2.6 – 123	2.6 – 118



Model	4E ◆★	5B ◆★	5S ◆★	6S ★	7S ★
Dimensions (in)	Ø1.562 x 0.953	Ø1.875 x 1.203	Ø1.875 x 1.047	Ø2.250 x 1.343	Ø2.750 x 1.766
Stroke	Up to 95°	Up to 95°	Up to 110°	Up to 110°	Up to 95°
Starting Torque (lb-in)	Up to 5.2	Up to 10.0	Up to 13.2	Up to 30.6	Up to 46.6
Holding Torque (lb-in)	Up to 2.0	Up to 4.0	Up to 5.0	Up to 9.0	Up to 20.0
Power (W)	12.5 – 250	21 – 420	21 – 420	32 – 640	35 – 700
Supply (V)	4.3 – 187	6.1 – 273	6.1 – 271	10.3 – 469	16.3 – 463

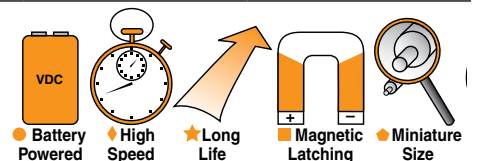

BTA® Brushless Torque Actuators



- Controllable velocity and position
- Quiet, shock-free operation
- 100+ million cycle life
- No axial stroke
- Adaptable to closed loop operation
- Completely enclosed construction
- Excellent unit-to-unit performance consistency
- Low power consumption

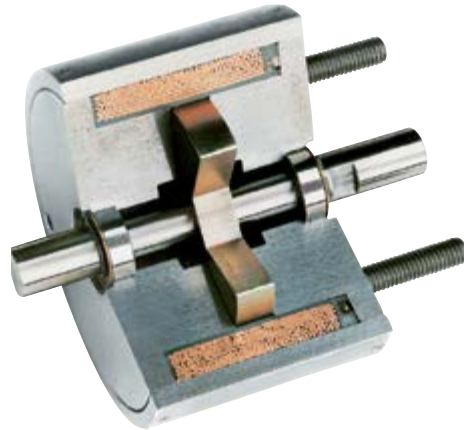

BTA® Principle of Operation

The BTA has a single phase coil with three stator poles and matching rotor poles. When the coil is energized, the poles align along the flux path. With the three pole design, it is possible to have a stroke of up to 45°. In practical usage, external stops should be used to attain maximum unit life. Subsequently, the stroke angle is slightly shorter. Use of such mechanical stops also serve to limit the actuator stroke to its optimum stroke/torque capacity. By not requiring full stroke actuation, the BTA offers maximum design flexibility across a wide range of stroke angles and torque requirements.

BTA rotary, non-axial stroke actuators are a good solution for applications requiring reliable, low hysteresis

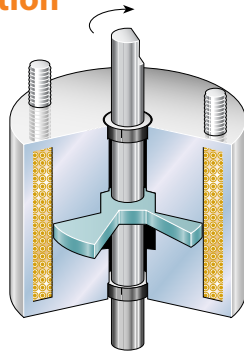

De-energized

operation with a good torque profile as required for proportional operation.

Using simple pulse width modulation (PWM) to control coil current, the BTA allows open or closed loop velocity and position control. Such proportional control is ideal for silent, shock-free actuation applications. (In open loop applications, PWM improves hysteresis over variable DC voltage control.)

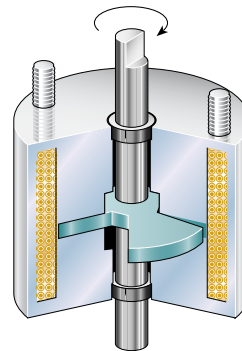

Energized

The addition of position feedback, and the subsequent improved system stiffness and accuracy, enables the BTA to be used in closed loop applications.

The bearing system consists of two ball-type bearings which are key to low hysteresis operation.

Quiet

The BTA can operate virtually noise free. Electronically controlled, the BTA provides soft, shock-free cycling without the noise associated with end-of-stroke mechanical stops.

For machines such as automated, high speed mail sorters which utilize hundreds of BTA actuators per machine, the BTA is used in conjunction with cushioned external stops to minimize noise, and extend the unit's life to that of the precision ball bearings.

Rapid Cycling

The BTA actuator requires only milliseconds to rotate through its entire stroke. It can maintain this extremely fast operating speed repetitively without diminishing accuracy or repeatability, or reducing the overall life of the unit.

Rugged

The BTA design eliminates the axial travel associated with conventional rotary actuators. In so doing, the BTA eliminates loading on associated mechanical linkages, and reduces the number of moving parts and the wear they receive. The BTA is self-contained in an industry standard size which enables easy mounting and interchangeability. The unit is permanently lubricated and requires no adjustment or maintenance over its entire life.

Powerful . . . with Less Power

The BTA actuator offers considerably more torque than comparable sized rotary actuator designs.

Even with its high torque output, the BTA requires 40% less power input than competitive units. On high volume applications such as this mail sorter, the BTA conserves as much as 18.9 watts per actuator cycle.

BTA® Design Considerations

Duty Cycle

Duty cycle is determined by: ON time/(ON + OFF time).

For example: an actuator operated for 30 seconds, then off for 90 seconds.

$$30 \text{ sec ON} / (30 \text{ Sec ON} + 90 \text{ sec OFF}) = 30/120 = 1/4 \text{ or } 25\% \text{ duty cycle}$$

BTA actuators are rated for various duty cycles ranging from continuous to 10% duty.

Life

When selecting a BTA actuator, as with any other style, it is important to consider the effects of heat on life. When used with a constant voltage supply, an increase in coil temperature reduces the work output and the life of the unit. Standard life is more than 100,000,000 cycles.

Power Requirements

Voltage applied to the actuator must be matched to the coil wire size for proper operation. Actuators are cataloged in coil awgs ranging from #23 up to #35 to accommodate your input power. Refer to the individual model specification pages for coil wire awg recommendations. Many other coil awg sizes are available. Please feel free to contact our application engineering department for availability.

Options and Modified Designs

Even though our standard BTAs are in stock, our customers often require a product with unique features or performance capabilities. In fact, almost 80% of all products that we make are either modified or custom built to meet our customers' exact application requirements.

Typical Examples of Custom Features

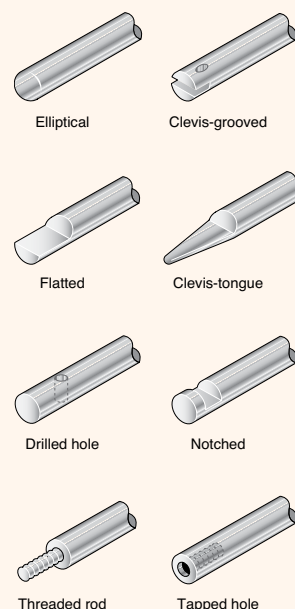

So, if you don't find what you're looking for in the catalog, give us a call to discuss your needs with one of our application engineers.

BTA® Selection Overview

Model Size	Package Dimensions (in)			Gross Starting Torque (lb-in) @ Specified Duty Cycle				Gross Ending Torque (lb-in) @ Specified Duty Cycle			
	Dia.	Length	Stroke	100%	50%	25%	10%	100%	50%	25%	10%
2EV ●◆★	1.188	0.719	45°	N/A*	0.28	0.50	1.00	N/A*	0.19	0.33	0.58
3EV ◆★	1.375	0.890	45°	0.28	0.45	0.84	1.66	0.22	0.31	0.53	0.88
4EV ◆★	1.625	1.055	45°	0.40	0.92	1.60	2.85	0.36	0.64	1.00	1.60
5EV ◆★	1.937	1.265	45°	1.36	2.36	3.72	6.00	1.04	1.64	2.60	4.20
6EV ◆★	2.312	1.625	45°	3.40	5.80	8.60	12.90	2.00	3.70	5.00	7.00

All data is at 20°C coil temperature. Torque outputs degrade with elevated temperatures.

* Not recommended for 100% duty.



Call our application engineers at 937.454.2345 or click here for complete BTA specifications, performance data, dimensions, selection and ordering information

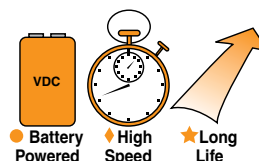

Ultimag® Rotary Actuators



- Speeds over 100 Hz
- Peak torque of over 225 oz-in
- 100 million actuation life
- Three standard sizes

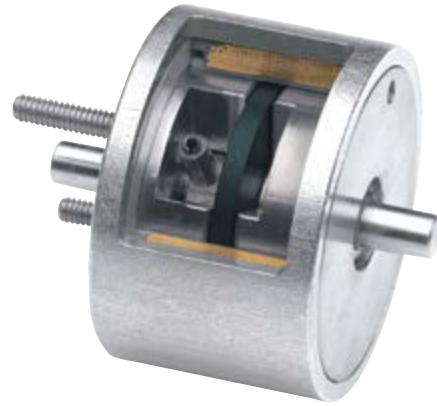

Ultimag® Principle of Operation

Ultimag® operates on the simple principle of attraction and repulsion of opposite and like magnetic poles. The permanent magnetic armature has twice as many poles as the stator. In the de-energized state, the armature poles each share half a stator pole, causing the shaft to seek mid-stroke. When power is applied, the stator poles are polarized. This attracts half and repels the other half of the armature poles, causing the shaft to rotate. When the voltage is reversed, the stator poles are polarized with the opposite pole. Consequently, the opposite poles of the armature are attracted and repelled, thus causing rotation in the opposite direction.

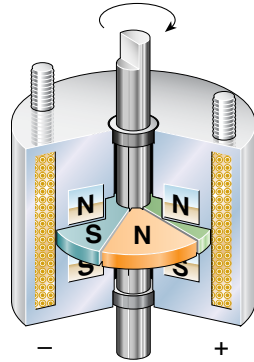

**Energized
(CCW rotation)**

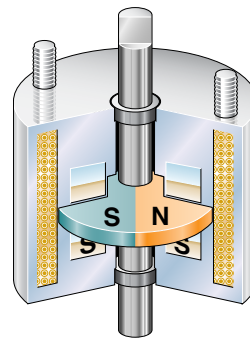

De-Energized

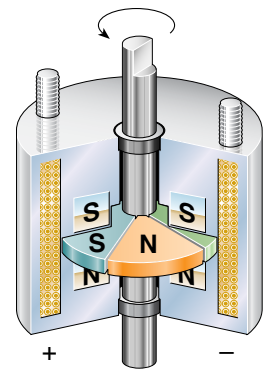

**Energized
(CW rotation)**

The Ultimag Series has been developed in response to application needs for higher speed and higher torque motion control components. We have found that many applications require a working stroke less than 360°, yet still employ motors

with their associated complex and expensive controls and linkages. As a result, a powerful, extremely fast short stroke actuator has many design advantages for industrial, office automation, automotive and medical applications.

We have been designing and manufacturing world class, innovative motion control components for over 60 years. Our patented Ultimag series is the latest of our state-of-the-art developments in rotary actuation products.

Ultimag® Design Considerations

Ultimag® offers a bidirectional, center return function not found in rotary solenoids. The Ultimag is substantially faster than other solenoids, and can be operated in an on/off mode or proportionally, in both open loop and closed loop systems.

The Ultimag does not offer 360° of rotation which is definitive of motors. With this stroke limitation in mind, Ultimag provides an inexpensive alternative for limited stroke applications, particularly, when total cost of system control is included.

Ultimag actuators offer a 45° stroke. However, the design is capable of a maximum stroke of 160°. Gears, belts, pulley, etc., can be employed to amplify stroke. In all cases, an increase in stroke will cause a reduction in torque.

For shorter strokes, electronic or mechanical stops can be used. By having a unit tooled to perform a specific stroke less than 45°, more torque will be obtained.

When adding the Ultimag to your application, the shaft must be supported to avoid stress fractures to the magnet.

Temperature Limitation

The permanent magnet in the Ultimag is NdFeB. For applications running above 130°C, we do not recommend the Ultimag, since the NdFeB magnets irreversibly degrade after reaching a 150°C temperature.

Duty Cycle

Duty cycle is determined by: ON time/(ON + OFF time).

For example: an actuator operated for 30 seconds, then off for 90 seconds.

$$30 \text{ sec ON} / (30 \text{ Sec ON} + 90 \text{ sec OFF}) = 30/120 = 1/4 \text{ or } 25\% \text{ duty cycle}$$

Ultimag actuators are rated for various duty cycles ranging from continuous to 10% duty.

Life

When selecting an Ultimag actuator, as with any other style, it is important to consider the effects of heat on life. When used with a

constant voltage supply, an increase in coil temperature reduces the work output and the life of the unit. Standard life is more than 100,000,000 cycles.

Power Requirements

Voltage applied to the actuator must be matched to the coil wire size for proper operation. Actuators are cataloged in coil awgs ranging from #23 up to #35 to accommodate your input power. Refer to the individual model specification pages for coil wire awg recommendations. Many other coil awg sizes are available. Please feel free to contact our application engineering department for availability.

Options and Modified Designs

Even though our standard BTAs are in stock, our customers often require a product with unique features or performance capabilities. In fact, almost 80% of all products that we make are either modified or custom built to meet our customers' exact application requirements.

Typical Examples of Custom Features

Power Take Off

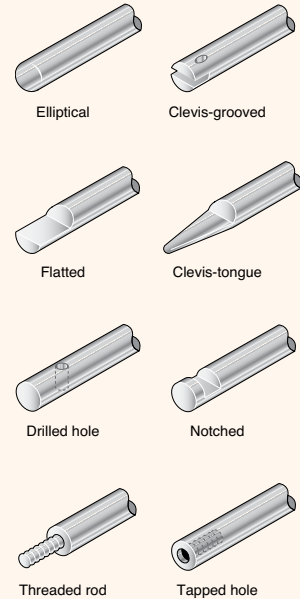

So, if you don't find what you're looking for in the catalog, give us a call to discuss your needs with one of our application engineers.

Ultimag® Selection Overview

Model Size	Package Dimensions (in)		Gross Starting Torque (lb-in) @ Specified Duty Cycle				Gross Ending Torque (lb-in) @ Specified Duty Cycle			
	Dia.	Length	100%	50%	25%	10%	100%	50%	25%	10%
4EM ♦★	1.625	1.04	0.88	1.25	1.80	2.88	0.18	0.50	0.88	1.68
5EM ♦★	1.937	1.31	2.00	2.88	3.90	6.30	0.32	0.94	2.00	3.88
6EM ♦★	2.312	1.60	5.00	6.10	10.00	14.00	2.50	3.80	5.00	7.30

All data is at 20°C coil temperature. Torque outputs degrade with elevated temperatures.

* Not recommended for 100% duty.



Call our application engineers at 937.454.2345 or click here for complete Ultimag specifications, performance data, dimensions, selection and ordering information

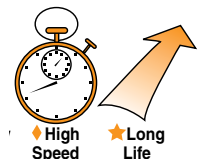

Ledex® Rotary Solenoids



- The most extensive rotary solenoid line in the industry
- Stock models available through distribution for next day shipment across North America
- Quantity orders for standard products delivered in 4–8 weeks
- Extensive capabilities for modified, custom fabricated solenoids and solenoid-operated mechanisms
- Fast, two-week turnaround on prototypes, small orders or custom models

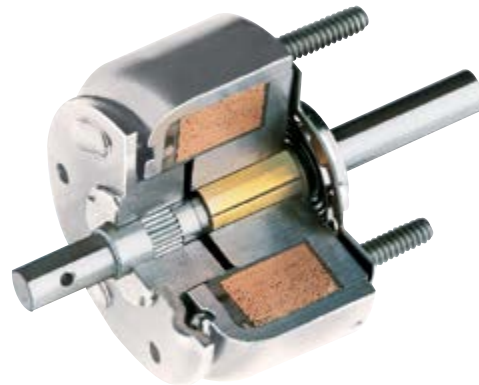

Ledex® Rotary Solenoid Design Principles

Physical Characteristics

The rotary solenoid is a compact and rugged direct current electromagnet—almost solid steel and copper so as to give maximum power output with minimum size and weight. The coil is wound by a special precision winding process which puts the maximum amount of copper into the allowable space, thus resulting in each solenoid developing a tremendous torque for its size and power output. Heat-treated steel surrounds and protects the coil. The steel also provides a magnetic path of high permeability and low residual flux characteristics for efficient conversion of electrical energy to mechanical energy and fast response.

Determining Rotary Stroke

The three ball races which determine the rotary stroke are produced by a coining process. The coining of the solenoid case and armature plate determines the length and direction of the stroke and the value of starting torque. Refer to the selection charts for the standard strokes available. Special rotary strokes can be engineered for solenoids which are made to order.

Converting Linear to Rotary Motion

The rotary solenoid armature is supported by three ball bearings that travel around and down inclined ball races. When power is applied, a powerful linear electromagnetic force pulls in the armature. Rotation

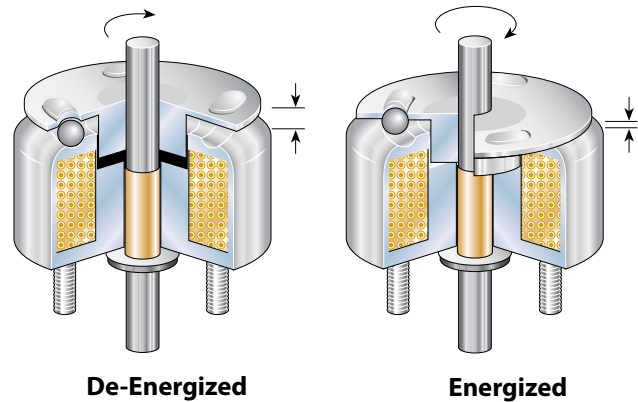

continues until the balls have traveled to the deep ends of the races. The result is almost frictionless conversion from linear to rotary motion.

High Starting Torque

In ordinary electromagnets, magnetic pull increases sharply as the air gap closes. In Ledex rotary solenoids,

this is compensated for by the compound angle of incline of the ball races. The incline of the ball races is steep at the beginning of the rotary stroke and gradually decreases as the balls approach the deep end of the ball races, thus transferring torque to the start of the rotary stroke where it is usually needed.

Ledex® Rotary Solenoid Coil Design Options

Ledex offers three rotary solenoid coil designs to accommodate most price and performance considerations.

Bobbin Wound Coil

Bobbin Coil Style solenoids (Sizes 3B and 5B only) offer good performance, long life and cost less than Precision Standard Coil Style solenoids. However, Bobbin Style solenoids provide somewhat less torque in a slightly taller package. Bobbin Style Solenoids are equipped with either solder lug terminals or lead wires.

- Manufactured by automated high-speed coil winding equipment for good performance and low cost
- Torque output up to 10 lb-in
- One million operations life rating (based on 25% duty cycle at 20°C ambient operating temperature)
- Standard strokes from 25°–110°; custom strokes available, some with one-time tooling charge
- Clockwise and counterclockwise rotation
- Wide variety of configurations to accommodate mounting and environmental considerations
- Many models available from distribution

Precision Standard Coil

Precision Standard Coil Style solenoids (Sizes 5S through 7S) are designed with precision wound coils to provide excellent performance and long life. Precision Standard solenoids are equipped with 10" PVC insulated lead wires.

- Precision wound coil for excellent torque to size ratio
- Available in standard or long life versions
- Torque output up to 47 lb-in
- One million operations life rating for standard versions; 50 million operations or 100 million operation if lubricated every 10 million operations for long life versions (life ratings based on 25% duty cycle at 20°C ambient operating temperature)
- Three sizes from 1-7/8" to 2-3/4" diameters
- Standard strokes from 25°–110°; custom strokes available, some with one-time tooling charge
- Clockwise or counterclockwise rotation
- Wide variety of configurations to accommodate mounting and environmental considerations
- Hundreds of models available from distribution

Precision Elongated Coil

Precision Elongated Coil Style solenoids (sizes 1E through 4E) also have precision-wound coils like our standard models, except the coil has 30% more copper. The larger coil enables Elongated styles to operate with additional torque at most power levels to provide an additional safety factor when compared to standard S style torque ratings. Consequently, Precision Elongated Coil Solenoids are generally recommended for applications which have relatively long duty cycle ON times. Precision elongated coils, in comparison to standard coils, weigh 20–25% more, have the same diameter and mounting configurations and are equipped with 10" PVC insulated lead wires.

- Built with 30% more coil copper than precision standard coil solenoids for lower power consumption
- Precision wound coil for excellent torque to size ratio
- Available in standard or long life versions
- Torque output up to 52 lb-in
- One million operations life rating for standard versions; 50 million operations or 100 million operations if lubricated every 10 million operations for long life versions (life ratings based on 25% duty cycle at 20°C ambient operating temperature)
- Four sizes from 1" to 1-9/16" diameters
- Standard strokes from 25°–110°; custom strokes available, some with one-time tooling charge
- Clockwise or counterclockwise rotation
- Wide variety of configurations to accommodate mounting and environmental considerations
- Many models available from distribution



Call our application engineers at 937.454.2345 or [click here](#) for complete rotary solenoid specifications, performance data, dimensions, selection and ordering information

Ledex® Rotary Solenoid Design Considerations

Rotary Stroke Considerations

Determine whether clockwise or counterclockwise rotation (as viewed from the armature side, opposite the mounting studs) is required.

Match the stroke of the solenoid selected to the rotary stroke required for the application. For example: do not use a 45° stroke solenoid when only 35° of stroke is needed.

The complete rotary stroke of the solenoid should be utilized. It is the contour of the ball race that determines the torque output, but if the armature is not allowed to completely energize or de-energize, the starting torque and ending torque will deviate from the designed torque output.

In some applications, however, users of standard Ledex solenoids have achieved good results with certain

methods of restricting the rotary stroke. If some mechanical means is used to prevent the balls from reaching the deepest part of the races, increased life expectancy and quieter operation can be achieved. However, if the stroke is restricted, it is often necessary that some additional bearing method be employed to keep the balls in phase. Our application engineers will be glad to assist you with any unusual requirements.

When strokes other than those shown in this catalog are needed in production quantities, it is usually best to consider tooling to produce the exact stroke needed.

Starting Torque

When determining an application's torque requirement, apply a 1.5 safety factor. For example: a load requiring 4.5 lb-in of torque should utilize a solenoid providing 4.5 x 1.5 or 6.75 lb-in of torque.

Snap-Acting Engagement

Rotary solenoids have fast acting engagement. If a controlled speed is required in a rotary stroke application, consider Ledex BTA rotary actuators.

Unobstructed Axial Stroke

Axial stroke is the linear distance that the armature travels to the center of the coil as the solenoid is energized and the three bearing balls travel to the lower ends of the races.

The application should allow clearance for axial stroke, which is rarely a problem due to the relatively small magnitude of travel. Axial stroke is listed for each solenoid size and rotary stroke on the appropriate specification pages.

Solenoids without axial stroke, such as our BTA, can be tailored to your application if longitudinal movement must be avoided.

Preloaded Axial Stroke

A rotary solenoid's armature produces smoother action if it is preloaded axially. It is important that the three bearing balls be kept in phase throughout the entire stroke. If they are allowed to move freely in the raceway, operation may become erratic.

Torque and Duty Cycle

Ledex rotary solenoids are engineered to deliver a relatively flat output curve at 25% duty.

Under highly intermittent usage such as 10% or 5% duty, power and magnetic saturation are increased. This results in a higher starting torque, but a faster reduction of torque as the armature progresses through the rotary stroke. Since most loads have some inertia, the effect of less torque toward the end of the stroke is usually negligible. At continuous duty, magnetic saturation is lower and the torque output typically increases slightly toward the end of stroke.

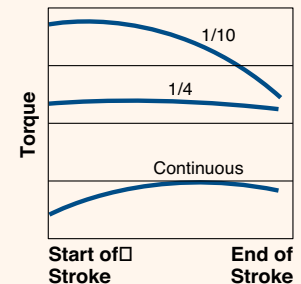
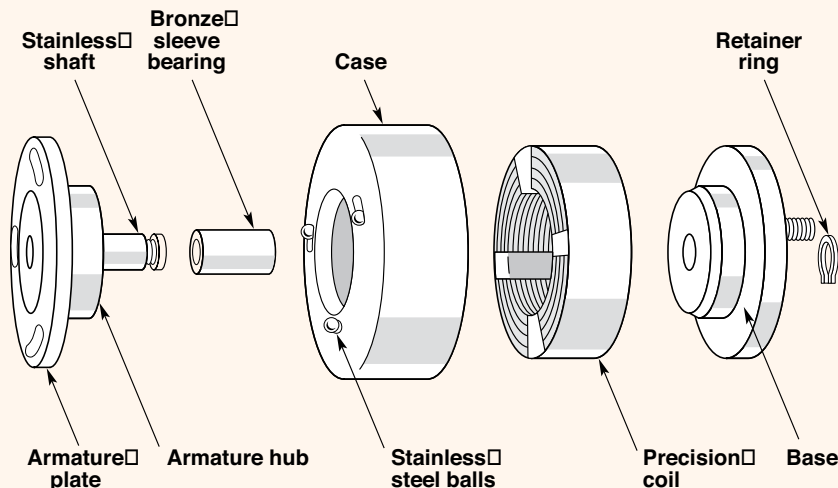

Ledex® Rotary Solenoid Design Considerations (cont.)

Torque and Stroke

Torque is inversely proportional to the total length of the rotary stroke. If, for example, a rotary solenoid with a 90° stroke produces a gross starting torque of 0.7 lb-in, it will have approximately 1.5 lb-in of torque if it has a 45° stroke, and 3.0 lb-in with a 25° stroke.

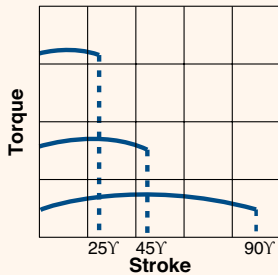

Temperature Considerations

Rotary solenoids are designed for operation in ambient temperatures ranging from -55°C to 80°C, provided the coil temperature does not exceed 120°C. Note that standard and elongated solenoids have PVC lead wires which have a maximum rating of 105°C. Special order Teflon leads are available (with maximum temperature rating of 200°C to allow for a 175°C coil temperature.)

Armature Drive Pin

Armature pins are commonly used as the main power take-off to perform secondary drive operations. They also provide a convenient adaptor for levers or bars which can convert the rotary stroke into linear motion. With appropriately designed linkages, a limited rotary stroke can produce several inches of linear travel.

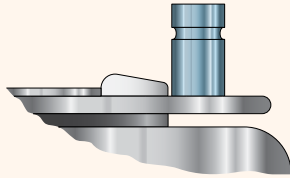

Life Ratings

Rotary solenoids are laboratory tested under spring load conditions at 25% duty cycle at 20° C ambient temperature to determine life ratings. Bobbin, Precision Standard, and Precision Elongated coil solenoids are rated for 1 million actuations.

Actual life, however, is greatly affected by the application and environment factors such as exposure to extreme temperatures, dirt, dust, etc. Depending on these factors, Precision Standard and Precision Elongated coil solenoids can provide up to 20 million actuations.

Duty Cycle

Duty cycle is determined by solenoid ON time/(ON + OFF time).

For example: a solenoid is actuated for 30 seconds, then off for 90 seconds.

$$30 \text{ sec ON} / (30 \text{ Sec ON} + 90 \text{ sec OFF}) = 30/120 = 1/4 \text{ or } 25\% \text{ duty cycle}$$

Ledex rates rotary solenoids for various duty cycles ranging from 100% to 5% duty.

If you cannot find an appropriate Style B Bobbin Coil solenoid which provides satisfactory torque and power, consider S Style Precision Standard Coil, or E Style Precision Elongated Coil models.

Maximum ON Time and Duty Cycle

Note: Maximum ON time for a particular application can be a factor which overrides duty cycle rating

For example, the maximum ON time for a given rotary solenoid when pulsed continuously at 25% duty cycle at given wattage is 36 seconds. If, however, the solenoid is given a single pulse at the same wattage with the unit at ambient temperature (20°C), then the maximum ON time is extended somewhat to 44 seconds. Maximum ON time ratings are charted by duty cycle.

Power Requirement

Standard solenoids are available in coil awgs ranging, in most instances, from #23 up to #33 to accommodate your input power. Refer to selection charts on the following pages. The coil awg number will determine the power rating of the coil. The coil awg number must be specified when ordering a unit. Many other awg coil sizes are available; please contact an application engineer to discuss your requirements.

Consider an In-Stock Model for Preliminary Evaluation

Many rotary solenoids are available from distribution inventory. If you're not sure of your exact requirement, you may consider using a stock model prototype as a quick and very inexpensive means to determine your exact requirements.



Call our application engineers at 937.454.2345 or [click here](#) for complete rotary solenoid specifications, performance data, dimensions, selection and ordering information

Ledex® Rotary Solenoid Modifications, Custom Capabilities, Configuration Options

Ledex custom fabricated solenoids are designed, built, tested, packaged, and shipped to your exact specifications. Whether it's as simple as adding a special connector or mounting bracket, or fabricating a complete assembly, we can build the right product to meet both your design and budget objectives.

Even though we offer thousands of standard rotary solenoid models, almost 80% of the product we build is specifically tailored to our customers' needs. So if you don't find exactly what you're looking for, please call us to discuss your requirements. Here are a few simple design options which we frequently encounter for rotary solenoid applications:

- Special shafts
- Mounting studs threaded to customer specification
- Slots, flats, or holes in shafts for machine linkage
- Double return springs for critical safety redundancy
- Armature covers

For modifications including heavy duty return springs, drive pins, etc., please contact our application engineers for assistance, as these standard modifications require a custom part number.

Return Springs

Return springs are employed to return the solenoid armature to its de-energized position, and can also serve to return light loads.

To meet exacting application requirements, rotary solenoids can be equipped with lesser or higher torsion return springs. Contact our application engineers for your specific requirements.

Long Life Versions

Precision Standard and Precision Elongated coil solenoids are also available in long life versions which provide 50 million actuations (or 100 million actuations if lubricated every 10 million actuations).

Long life models incorporate precision needle bearings and special materials to reduce wear and extend life. The needle bearing is particularly helpful in overcoming side load and starting torque problems.

Long life models provide approximately 90% of the charted torque listed in the performance charts. Long life models are slightly more expensive, but can cost less in terms of machine down time and replacement time. Long life versions are available in strokes up to 45°. Please consult the factory for longer strokes.

Standard Configuration Options

Rotary solenoids are available in seven standard configurations for most sizes: All configurations include a return spring.

Armature covers are available on all models, sizes and styles. They keep adjacent components or wires from interfering with the rotary and axial motion of the solenoid armature. They are also recommended for dirty or dusty environments. Armature cover models with armature end shaft extensions are equipped with a felt washer to act as a seal against the entry of dust around the shaft.

Models without an armature cover are equipped with three tapped holes in the armature face for load attachment purposes.

Armature End Shaft
Extension and
Tapped Holes

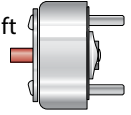

Base End Shaft
Extension and
Tapped Holes

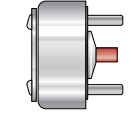

No Shaft
Extensions and
Tapped Holes

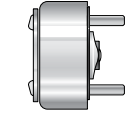

Armature and
Base End Shaft
Extensions

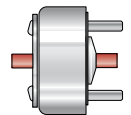

Armature Cover
with Armature
End Shaft Extension

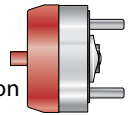

Armature Cover
with Base End
Shaft Extension

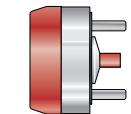

Armature Cover
with Armature
End and Base End
Shaft Extensions

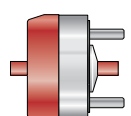

Call our application engineers at 937.454.2345 or [click here](#) for complete rotary solenoid specifications, performance data, dimensions, selection and ordering information

Rotary Solenoids Selection Overview

Size/ Series	Diameter ¹ (in)	Height ¹ (in)	Stroke	Direction		Holding Torque (lb-in)	Available Torque ² (lb-in)					Energizing Time (msec) @ Specified Duty Cycles					Return Spring (lb-in)	
				CW	CCW		100% Duty	50% Duty	25% Duty	10% Duty	5% Duty	100% Duty	50% Duty	25% Duty	10% Duty	5% Duty		
1E ◆◆ ★◆	1.000	0.625	25°	•	•	0.3	*	0.2	0.4	0.8	1.1	12.6	9.9	7.3	5.7	4.7	0.06	
			35°	•	•	*	*	*	*	*	*	*	*	*	*	*	*	*
			45°	•	•	0.2	*	0.1	0.2	0.4	0.6	19.8	14.2	10.0	7.2	6.0	0.06	
2E ◆◆ ★	1.125	0.656	25°	•	•	0.5	0.2	0.4	0.7	1.4	1.7	13.1	9.5	7.5	5.9	5.0	0.06	
			35°	•	•	*	0.2	0.3	0.5	1.1	1.3	*	*	*	*	*	*	
			45°	•	•	0.3	0.1	0.2	0.4	0.7	0.9	23.2	15.0	11.0	8.4	7.0	0.06	
3B ◆★	1.312	0.875	25°	•	•	0.9	0.4	0.7	1.3	2.7	3.2	16.5	11.3	8.9	6.8	5.9	0.12	
			35°	•	•	0.6	0.3	0.6	1.0	2.0	2.3	*	*	*	*	*	*	
			45°	•	•	0.4	0.2	0.4	0.8	1.4	1.7	24.0	15.6	12.1	9.4	7.7	0.12	
			67-1/2°	•	•	0.4	0.1	0.2	0.4	0.5	0.8	*	*	*	*	*	*	
3E ◆★	1.312	0.797	25°	•	•	0.9	0.4	0.8	1.4	2.7	3.2	16.9	12.0	9.3	7.1	6.2	0.12	
			35°	•	•	0.7	0.3	0.6	1.0	2.0	2.3	*	*	*	*	*	*	
			45°	•	•	0.6	0.2	0.4	0.8	1.4	1.8	29.8	17.8	13.1	10.0	8.1	0.12	
			67-1/2°	•	•	0.5	0.1	0.2	0.4	0.7	0.9	*	*	*	*	*	*	
4E ◆★	1.562	0.953	25°	•	•	2.0	0.9	1.7	3.1	4.5	5.2	19.1	13.9	11.2	8.3	7.2	0.18	
			35°	•	•	*	0.6	1.1	2.0	3.1	3.5	*	*	*	*	*	*	
			45°	•	•	1.0	0.4	0.9	1.6	2.6	3.1	28.9	20.3	15.4	11.3	9.2	0.18	
			55°	•	•	*	*	*	*	*	*	*	*	*	*	*	*	
			67-1/2°	•	•	*	0.2	0.4	0.8	1.6	1.9	*	*	*	*	*	*	
5B ◆★	1.875	1.203	25°	•	•	4.0	1.8	3.5	5.8	8.3	10.0	19.6	14.9	12.0	9.4	7.7	0.25	
			35°	•	•	0.9	0.9	2.1	4.1	6.9	8.3	*	*	*	*	*	*	
			45°	•	•	3.0	0.7	1.7	3.2	5.0	6.0	29.0	21.2	16.5	12.6	10.2	0.25	
			67-1/2°	•	•	0.5	1.1	2.0	3.3	4.0	4.0	*	*	*	*	*	*	
			95°	•	•	2.0	0.2	0.4	0.9	1.6	1.9	*	*	*	*	*	*	
5S ◆★	1.875	1.047	25°	•	•	5.0	1.9	4.1	7.3	12.1	13.2	18.6	14.3	11.5	9.0	7.2	0.25	
			35°	•	•	*	1.2	2.6	4.5	7.8	9.2	*	*	*	*	*	*	
			45°	•	•	3.0	0.7	1.7	3.4	6.3	6.9	28.1	20.3	15.6	12.0	10.0	0.25	
			55°	•	•	*	*	*	*	*	*	*	*	*	*	*	*	
			67-1/2°	•	•	*	0.5	1.2	2.2	3.9	4.9	*	*	*	*	*	*	
			75°	•	•	*	*	*	*	*	*	*	*	*	*	*	*	
6S ★	2.250	1.343	25°	•	•	9.0	4.6	8.9	16.2	27.8	30.6	24.1	18.6	14.8	11.4	9.5	0.50	
			35°	•	•	*	3.4	6.5	12.0	18.6	20.5	*	*	*	*	*	*	
			45°	•	•	6.0	1.7	3.5	6.5	11.0	12.1	38.1	27.4	21.6	16.5	13.5	0.50	
			55°	•	•	*	*	*	*	*	*	*	*	*	*	*	*	
			67-1/2°	•	•	*	1.6	3.1	5.6	8.8	9.7	*	*	*	*	*	*	
7S ★	2.750	1.766	25°	•	•	20.0	11.0	23.8	33.2	42.4	46.6	32.3	25.1	20.3	15.6	13.2	0.75	
			35°	•	•	*	6.0	12.0	22.0	38.0	42.0	*	*	*	*	*	*	
			45°	•	•	13.0	5.0	8.8	16.4	29.8	32.8	45.1	33.9	27.2	20.2	16.9	0.75	
			55°	•	•	*	*	*	*	*	*	*	*	*	*	*	*	
			67-1/2°	•	•	*	2.5	5.1	9.8	17.5	19.3	*	*	*	*	*	*	
95°	•	•	6.0	1.5	3.5	6.4	10.5	11.6	81.6	58.8	44.8	33.0	27.3	0.75				

All data is at 20°C coil temperature. Torque outputs degrade with elevated temperatures.

¹ Without armature cover

² Torque values and energizing times shown for S and E Series are for Standard Life units. Long Life models (only available in strokes up to 45°), provide approximately 10% less torque, but offer 5 to 10 times longer life.

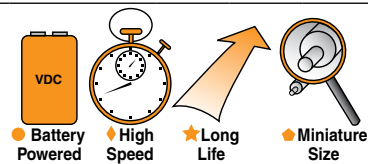

* Consult factory for sizes and strokes not shown.



Linear Solenoid Functional Comparison At-a-Glance

From the chart below, choose the solenoid design with characteristics best suited to your application requirements. Then, refer to the following pages for more detailed information by series and model.

Follow the links to our website for complete performance ratings, technical data, and mechanical specifications.

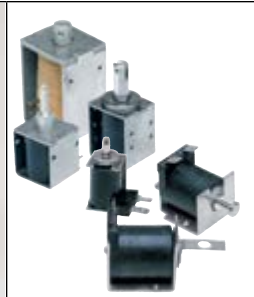
				
	STA® Tubular Solenoids	Soft Shift® Solenoids	Low Profile Solenoids	Open Frame Solenoids
Stroke	Up to 2.5" (63.5 mm)	Up to 0.42" (10.7 mm)	Up to 0.7" (17.78 mm)	Up to 1.00" (25.4 mm)
Attributes:				
Battery Powered —	•	•	•	•
High Speed —	•	•	•	•
Long Life —	•	•	•	•*
Magnetic Latching —	•	•	•	•
Miniature Size —	•	•	•	•
Quiet Performance —	•	•	•	•
Max Power Output (Torque or Force)	Up to 9.8 lbs (43.61 N)	Up to 29.5 lbs (131.28 N)	Up to 145 lbs (645.2 N)	Up to 11.0 lbs (48.9 N)
Power Consumption	Average	Average	Average	Average
Duty Cycle	Continuous or intermittent	Continuous or intermittent	Continuous or intermittent	Continuous or intermittent
Housing Style (with a variety of options for:	Completely enclosed	Completely enclosed	Completely enclosed	Compact box and C frame design
Shaft Ends —	•	•	•	•
Mounting Styles —	•	•	•	•
Power Termination —	•	•	•	•
Imperial and Metric —	•	•	•	•
Operational Characteristics	<ul style="list-style-type: none"> Economical design for volume applications Multiple plunger designs Greatest shock/vibration integrity On/off operation Push or pull models; ideal for lock/latch operations 	<ul style="list-style-type: none"> Slow, smooth motion or snap action Can provide closed loop velocity control Quiet operation with 3-5 times the starting force of standard solenoids Push or pull models 	<ul style="list-style-type: none"> Ideal for high force, short stroke applications On/off operation Push or pull models; ideal for lock/latch operations 	<ul style="list-style-type: none"> Most economical design for volume applications DC activated Continuous or intermittent duty On/off operation Pull models standard (push models available)
Life (millions of cycles; field-proven)	25+; for STA; 1 for Size 125-175	10	1 to 5	Up to 5
Size	10 sizes: <ul style="list-style-type: none"> Diameters from 1/2" to 1-3/4" (13 to 45 mm) Lengths from 1/2" to 4.75" (13 to 121 mm) long 	5 sizes: <ul style="list-style-type: none"> Diameters from 1-1/8" to 2-1/4" (29 to 57 mm) Lengths from 1" to 2-1/4" (25 to 57 mm) long 	9 sizes: <ul style="list-style-type: none"> Diameters from 3/4" to 3-3/8" (10 to 86 mm) Lengths from 1/2" to 2-1/8" (13 to 54 mm) 	14 sizes: <ul style="list-style-type: none"> H x W x L from 0.4 x 0.3 x 0.6" (10 x 8 x 16 mm) to 2.0 x 1.7 x 3.0 (52 x 44 x 78 mm)

* Select models

Overview Comparison by Model



STA® Tubular Solenoids

Model	STA 1/2 X 1/2 ●◆★◆	STA 1/2 X 1/2 Latch ●★◆◆	STA 1/2 X 1 ●◆★◆	STA 1/2 X 2 ●★◆
Dimensions (in)	Ø0.52 x 0.55	Ø0.52 x 0.62	Ø0.52 x 1.05	Ø0.52 x 2.05
Stroke (in)	Up to 0.1 Pull or Push	Up to 0.15 Pull	Up to 0.5 Pull or Push	Up to 0.8 Pull
Force (lb)	Up to 1.9	Up to 23	Up to 2.5	Up to 1.6
Power (W)	3 – 30	3 – 30	4 – 40	4.8 – 48
Supply (V)	1.2 – 38	1.2 – 38	2.4 – 77	3.1 – 91

Model	STA 3/4 X 1-1/2 ●◆★◆	STA 1 x 1-1/8 ◆★	STA 1 X 2 ◆★	STA 1-1/2 X 1-1/2 ★
Dimensions (in)	Ø0.77 x 1.56	Ø1.02 x 1.175 Pull	Ø1.02 x 2.05 Pull	Ø1.02 x 2.05 Pull or Push
Stroke (in)	Up to 0.7 Pull or Push	Up to 0.48 Pull	Up to 0.7	Up to 0.7
Force (lb)	Up to 10	Up to 10	Up to 24	Up to 24
Power (W)	7 – 70	8.5 – 85	10 – 100	10 – 100
Supply (V)	3.9 – 76	2.7 – 89	4.4 – 142	4.4 – 142

Standard Pull Tubular Solenoids

Model	Size 125	Size 150
Dimensions (in)	Ø1.25 x 2.25 Pull	Ø1.50 x 2.50 Pull
Stroke (in)	Up to 0.7	Up to 0.8
Force (lb)	Up to 13	Up to 20
Power (W)	13 – 130	17 – 170
Supply (V)	6.8 – 128	9.8 – 315

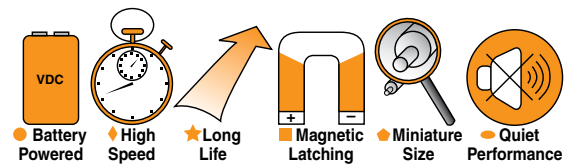

Linear Solenoid Functional Comparison At-a-Glance

Overview Comparison by Model



Soft Shift® Solenoids

Model	2EP ●★●	3EP ★	4EP ★●●	5EP ★	6EP ★●●
Dimensions (in)	Ø1.125 x 0.996	Ø1.312 x 1.232	Ø1.562 x 1.471	Ø1.875 x 1.935	Ø2.250 x 2.214
Stroke (in)	Up to 0.16	Up to 0.25	Up to 0.30	Up to 0.40	Up to 0.42
Force (lb)	Up to 3.8	Up to 4.3	Up to 7.5	Up to 12.5	Up to 29.5
Power (W)	7 – 70	9 – 90	12.5 – 125	21 – 210	32 – 320
Supply (V)	2.2 – 91	2.6 – 83	4.3 – 132	7.2 – 226	12.3 – 394



Low Profile Solenoids

Model	0EC ●◆◆	1EC ●◆◆	2EF/2EC ●◆	3EF/3EC ◆
Dimensions (in)	Ø0.75 x 0.5	Ø1.0 x 0.53	Ø1.125 x 0.58	Ø1.312 x 0.69
Stroke (in)	Up to 0.15	Up to 0.24	2EF: Up to 0.075 2EC: Up to 0.24	3EF: Up to 0.075 3EC: Up to 0.3
Force (lb)	Up to 5	Up to 9	2EF: Up to 34 2EC: Up to 10	3EF: Up to 40 3EC: Up to 18
Power (W)	4.5–45	5–50	7–70	9–90
Supply (V)	1.6–78	2.1–83	2.2–56	2.6–83

Model	4EF/4EC ◆	5SF/5EC ◆	6SF/6EC	7EC	8EC
Dimensions (in)	Ø1.562 x 0.835	5SF: Ø1.875 x 0.88 5EC: Ø1.875 x 1.035	6SF: Ø2.25 x 1.145 6EC: Ø2.25 x 1.33	Ø2.750 x 1.780	Ø3.375 X 2.165
Stroke (in)	4EF: Up to 0.12 4EC: Up to 0.25	5SF: Up to 0.14 5EC: Up to 0.4	6SF: Up to 0.18 6EC: Up to 0.4	Up to 0.70	Up to 0.70
Force (lb)	4EF: Up to 72 4EC: Up to 24	5SF: Up to 100 5EC: Up to 40	6SF: Up to 190 6EC: Up to 75	Up to 80	Up to 175
Power (W)	12.5–125	21–210	32–320	35–350	41–410
Supply (V)	4.3–132	5SF: 6.1–192 5EC: 7.2–226	6SF: 10.3–331 6EC: 12.3–394	19–600	29–529

Box Frame Solenoids

Model	B4HD	B11HD	B12 ●◆◆
Dimensions H x W x L (in)	1.63 x 1.45 x 2.18	1.25 x 0.94 x 2.00	0.40 x 0.32 x 0.63
Stroke (in)	Up to 1.00	Up to 0.70	Up to 0.20
Force (lb)	Up to 16.1	Up to 11	Up to 8.8
Power (W)	12.5–125	9–90	1.3–13
Supply (V)	6–388	6.1–382	3–76



Model	B14/B14-L/B14HD ●★□	B17/B17-L ●◆◆	B20 ●	B22/B22-L ■
Dimensions H x W x L (in)	1.02 x 0.79 x 1.45	0.59 x 0.51 x 0.79	0.94 x 0.81 x 1.14	1.47 x 1.31 x 1.61
Stroke (in)	Up to 0.6	Up to 0.18	Up to 0.5	Up to 1.00
Force (lb)	Up to 10.0	Up to 1.6	Up to 6	Up to 15
Power (W)	5.2–55	1.6–16	4.5–45	9.9–99
Supply (V)	3–76	3–153	6–380	6–385

Model	B28	B28HD	B41	B75M ●
Dimensions H x W x L (in)	1.19 x 0.94 x 1.13	1.25 x 0.94 x 1.23	2.03 x 1.73 x 3.05	1.14 x 1.10 x 1.63
Stroke (in)	Up to 0.75	Up to 0.48	Up to 1.00	Up to 0.6
Force (lb)	Up to 6.5	Up to 12	Up to 32	Up to 12
Power (W)	5.2–52	6.2–62	19–190	6–60
Supply (V)	6.4–376	6–374	6–388	6–153

C Frame Solenoids

Model	C5/C5-L ●◆◆	C8/C8-L ●◆■	C26
Dimensions H x W x L (in)	0.46 x 0.41 x 0.94	0.81 x 0.75 x 1.13	0.90 x 0.85 x 1.73
Stroke (in)	Up to 0.2	Up to 0.5	Up to 0.75
Force (lb)	Up to 1.2	Up to 3.5	Up to 3.2
Power (W)	3–30	3.6–35	7–70
Supply (V)	3–76	3–366	6–382

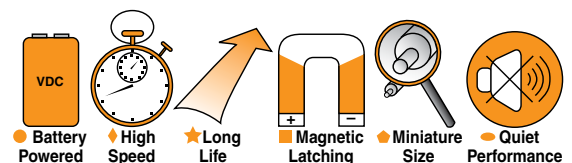

STA® Tubular Solenoids



Principle of Operation

In Pull type solenoids, the plunger is pulled into the solenoid coil when the coil is energized. In Push type solenoids, the same is true, however, the plunger has a shaft extension which then pushes out through a hole in the end of the solenoid case. Please note, however, that the magnetic field cannot be reversed to cause the opposite action to occur.

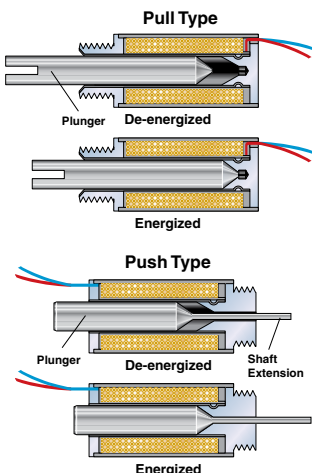

STA® Series tubular solenoids improve performance and provide longer life, quieter operation and improved reliability for demanding applications.

STA models are constructed with a low friction nylon bobbin which insures a 25 million actuations life rating on all models.

The problems associated with powdered metal flaking in typical tubular designs is eliminated with the metal-to-plastic bearing surface. In addition, the new design's case is rolled over both ends of the unit for greater shock and vibration integrity, allowing the STA to withstand severe applications in which typical solenoids may come apart.

Both push and pull models offer a built-in combination air gap spacer and plunger stop. This feature eliminates the need for external E-rings and impact washers which typically fail prematurely, as well as get in the way of your attached mechanisms.

- Industry standard-setting linear actuation performance
- New STA-D and STA-Q for quiet operation
- Push and pull models
- Strokes up to 2-1/2"
- Life rating of 25 million actuations for STA designs

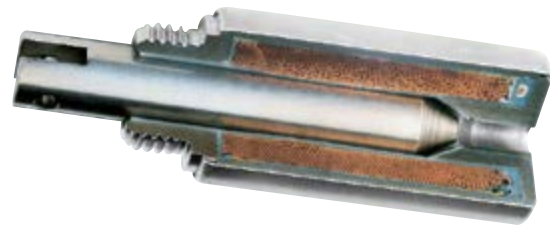

All units are provided with 10" PVC lead wires as standard, and are rated for a maximum coil temperature of 130°C. UL-approved materials are used in the construction.

For higher temperature applications up to 180°C, please consult the factory for alternate materials which are available in some models. Mechanical and electrical ratings may also be affected.

Other options include: special plunger configurations, springs, special mounting features, and anti-rotation flats on mounting bushings. Please consult the factory with details about your application as tooling may apply to some features.

For heavy duty applications requiring larger forces, Ledex Size 125, 150 and 175 standard tubular models are recommended. These standard models are all pull type with 60° plungers, and feature heavy duty welded mounting brackets or bushing mounts (depending on model), and heavy duty plunger stops to limit plunger travel, provide positive stopping, and keep pole faces from slamming together at the end of stroke. An impact cushion made of resilient non-magnetic material absorbs energy at the end of the stroke and helps eliminate residual magnetism.

Standard models are also available with other plunger configurations, in push type models, and with other mountings — please consult the factory.

NEW! STA Quiet Tubular Models

D2 Series

- Utilize New Dampened Floating Base Technology
- Energizing impact noise reduces approximately 20 dBA
- Virtually no reduction in high holding force compared to comparable standard model

Q Series

- Utilize Quiet Technology
- Energizing impact noise reduced to approximately 45 dBA
- Reduces holding force to low level



Design Considerations

Starting Force

When determining an application's force requirement, apply a 1.5 safety factor. For example: a load requiring 4.5 lb of force should utilize a solenoid providing 4.5 x 1.5 or 6.75 lb of force.

Duty Cycle

Duty cycle is determined by: ON time/(ON + OFF time).

For example: a solenoid is actuated for 30 seconds, then off for 90 seconds.
 $30 \text{ sec ON} / (30 \text{ Sec ON} + 90 \text{ sec OFF}) = 30/120 = 1/4$ or 25% duty cycle.

Ledex tubular solenoids are rated for various duty cycles ranging from continuous to 10% duty.

Life

When selecting a tubular solenoid, as with any other solenoid style, it is important to consider the effects of heat on life. When used with a constant voltage supply, an increase in coil temperature reduces the work output and the life of the unit. Standard life is 25,000,000 actuations for STA designs.

Power Requirements

Voltage applied to the solenoid must be matched to the coil wire size for proper operation. Solenoids are cataloged in coil awgs ranging from #23 up to #37 to accommodate your input power. Many other coil avg sizes are available. Please feel free to contact our application engineering department for availability.

Plunger Configurations

Flat Face



For strokes typically less than 0.060", the flat face plunger is recommended with a pull or push force three to five times greater than 60° plungers.

60° Angle



For longer strokes up to 0.80" (20.3 mm), the 60° plunger offers the greatest advantage over the flat face plunger.

Typical Examples of Custom Features

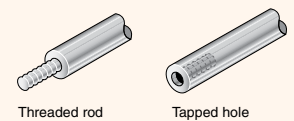
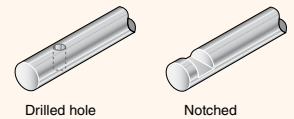
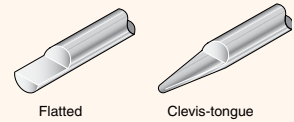
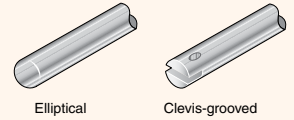

Options and Modified Designs

Even though many tubular models are in stock, our customers often require a product with unique features or performance capabilities. In fact, almost 80% of all solenoids that we make are either modified or custom built to

meet our customers' exact application requirements. Please give us a call to discuss your needs with one of our application engineers.

Tubular Selection Overview

Size	Solenoid Type	Package Dimension (in)		Max Stroke (in)	Nominal Stroke (in)	Force (lbs) @ Nominal Stroke and Specified Duty Cycle			
		Dia.	Length			100%	50%	25%	10%
STA 1/2" x 1/2"	Pull	0.52	0.55	0.10	0.05	0.18	0.30	0.50	1.00
MagLatch 1/2" x 1/2"	Pull	0.52	0.62	0.15	0.075	-	0.25	0.48	0.75
STA 1/2" x 1/2"	Push	0.52	0.55	0.10	0.05	0.08	0.18	0.25	0.60
STA 1/2" x 1"	Pull	0.52	1.05	0.50	0.10	0.19	0.31	0.56	1.00
STA 1/2" x 1"	Push	0.52	1.05	0.50	0.10	0.13	0.25	0.48	0.94
STA 1/2" x 2"	Pull	0.52	2.05	0.80	0.30	0.06	0.12	0.23	0.41
STA 3/4" x 1-1/2"	Pull	0.77	1.55	0.70	0.20	0.50	1.00	1.63	2.69
STA 3/4" x 1-1/2"	Push	0.77	1.55	0.70	0.20	0.38	0.80	1.50	2.75
STA 1" x 1-1/8"	Pull	1.02	1.175	0.50	0.10	1.75	2.90	4.80	8.20
STA 1" x 2"	Pull	1.02	2.05	0.70	0.30	0.90	1.75	3.00	5.20
STA 1" x 2"	Push	1.02	2.05	0.70	0.30	0.75	1.88	2.90	5.20
STA 1-1/2" x 1-1/2"	Pull	1.52	1.68	1.00	0.40	1.20	2.20	4.25	8.75
STA 1-1/2" x 1-1/2"	Push	1.52	1.68	0.75	0.40	0.70	1.50	2.80	6.30
Size 125 1-1/4" x 2-1/4"	Pull	1.25	2.25	0.70	0.40	1.00	2.00	4.00	6.50
Size 150 1-1/2" x 2-1/2"	Pull	1.50	2.50	0.80	0.40	1.00	2.50	5.20	9.80

All data is at 20°C coil temperature. Force outputs degrade with elevated temperatures.

*The new STA-D and STA-Q Quiet Tubular models have a slightly longer package dimension than standard STA 3/4 x 1-1/2, with comparable stroke, speed and force performance.



Call our application engineers at 937.454.2345 or click here for complete STA tubular specifications, performance data, dimensions, selection and ordering information

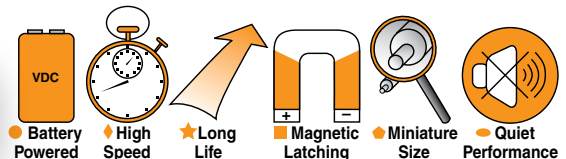

Soft Shift® Solenoids



- Variable positioning linear device
- Slow, smooth motion
- High starting force
- Quiet operation
- 10 million actuation life rating

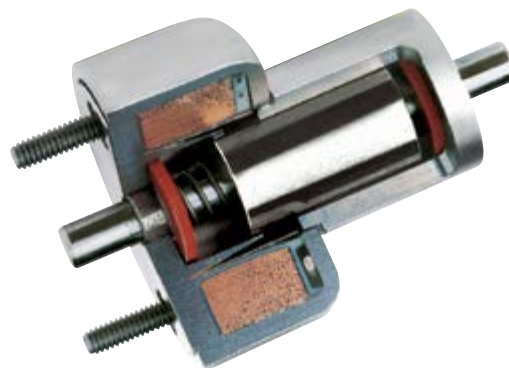

Principle of Operation

Soft Shift® solenoids have a unique construction which allows easy transition from snap action to variable position.

Using the same power, starting force is three to five times higher than standard solenoids at the fully de-energized position. This is advantageous for starting inertial loads or detented mechanisms, and for conserving electrical power.

In snap action applications, typical solenoids move to the end of the stroke within milliseconds, with a characteristic increase in ending force and acceleration. With the Soft Shift solenoid plunger, however, velocity can be controlled by ramping the input current for slow, noiseless operation.

For applications where variable positioning is desired, closed loop control can be accomplished by adding electronic controls. This gives accurate, repeatable action.

The essentially horizontal force curves prevent rapid acceleration at the end of the stroke, avoiding the excessive wear, noise and vibration that characterize standard solenoids. A Soft Shift solenoid can be a low-cost alternative to a linear stepping motor with a lead screw for up to and including a 0.420" stroke.

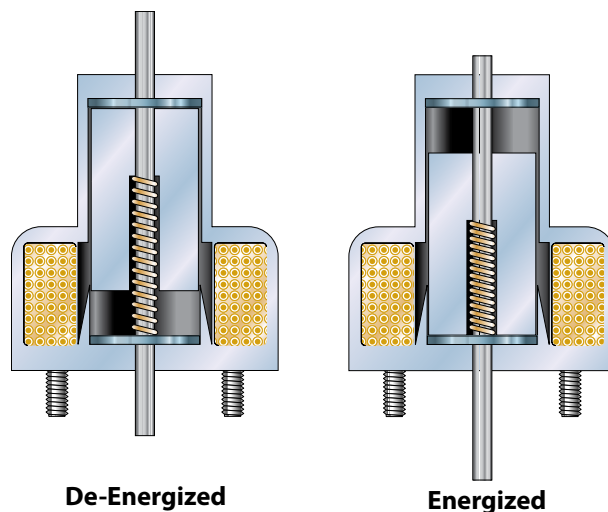

Design Considerations

Starting Force

When determining an application's force requirement, apply a 1.5 safety factor. For example: a load requiring 4.5 lb of force should utilize a solenoid providing 4.5 x 1.5 or 6.75 lb of force.

Duty Cycle

Duty cycle is determined by: ON time/(ON + OFF time).

For example: a solenoid is actuated for 30 seconds, then off for 90 seconds.
 $30 \text{ sec ON} / (30 \text{ Sec ON} + 90 \text{ sec OFF}) = 30/120 = 1/4$ or 25% duty cycle.

Soft Shift solenoids are rated for various duty cycles ranging from continuous to 10% duty.

Note that maximum ON time for a particular application can be a factor which overrides the duty cycle rating.

Life

When selecting a Soft Shift solenoid, as with any other solenoid style, it is important to consider the effects of heat on life. When used with a constant voltage supply, an increase in coil temperature reduces the work output and the life of the unit. Standard life is 10 million operations.

Power Requirements

Voltage applied to the solenoid must be matched to the coil wire size for proper operation. Solenoids are cataloged in coil awgs ranging from #23 up to #35 to accommodate your input power. Many other coil awg sizes are available. Please feel free to contact our application engineering department for availability.

Options and Modified Designs

Even though many Soft Shift models are in stock, our

Typical Examples of Custom Features

Termination

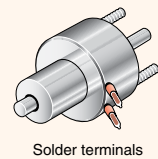
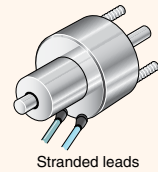
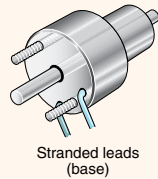
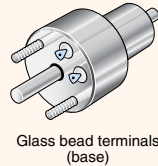

Power Take Off

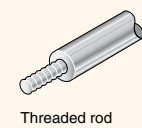
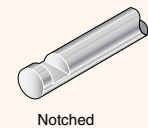
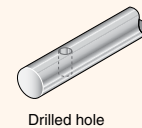
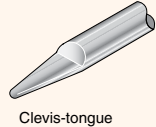
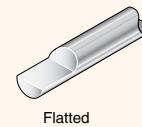
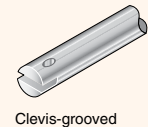
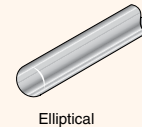

customers often require a product with unique features or performance capabilities. In fact, almost 80% of all solenoids that we make are either modified or

custom built to meet our customers' exact application requirements. Please give us a call to discuss your needs with one of our application engineers.

Soft Shift Selection Overview

Size	Package Dimensions (in)		Maximum Stroke (in)	Force (lbs) @ Maximum Stroke and Specified Duty Cycle			
	Dia.	Length		100%	50%	25%	10%
2EP ●★●●	1.125	0.996	0.16	1.0	1.4	2.0	3.8
3EP ★●●	1.312	1.232	0.25	1.0	1.9	2.3	4.3
4EP ★●●	1.562	1.471	0.30	2.0	3.0	4.3	7.5
5EP ★●●	1.875	1.935	0.40	3.0	4.5	7.0	12.5
6EP ★●●	2.250	2.214	0.42	7.0	9.6	16.0	29.5

All data is at 20°C coil temperature. Force outputs degrade with elevated temperatures.

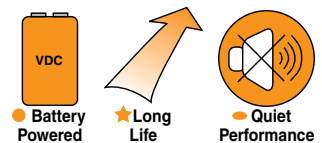

Call our application engineers at 937.454.2345 or click here for complete Soft Shift specifications, performance data, dimensions, selection and ordering information

Ledex® Low Profile Solenoids



- Linear actuation
- Space-saving, low-profile configuration
- Ideal for high force, short stroke applications
- Forces to 190 lbs.
- Stroke lengths to 0.7 inches

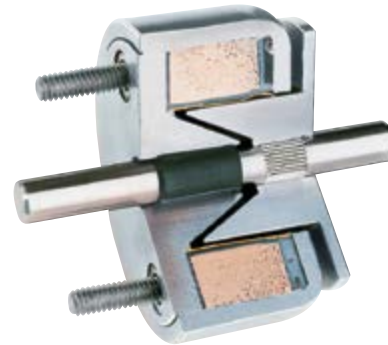

Principle of Operation

The low profile shape, besides contributing to smaller size, optimizes the magnetic flux paths for maximum force versus stroke characteristics. The construction of the plunger assembly provides an auxiliary flux path which permits a significant increase in force. The low profile solenoid construction not only provides long life, but also provides a rugged design for both military and commercial applications.

Conical-faced designs extend the useful range of a solenoid to provide higher forces for strokes typically over 0.060 inches. The pole surface area is greater and the distance between the tapered cone faces is

approximately one-half that of the gap between the land faces (for 30° angles), providing the effect of a closer air gap.

While some of the force component is lost because the force vector is not parallel with the plunger motion, the shorter gap and higher flux density combine to provide more output force for longer strokes.

For shorter strokes, the magnetic flux density increases and causes the iron to saturate rapidly as the poles move closer, thus reducing the efficiency of the conical-faced design. At this point, the flat-faced plunger is more efficient.

The main advantage of the flat-faced pole over the conical is that the full component of force is usable because the force vector is parallel with the pole motion.

A key to the efficiency and compact form factor of the low profile solenoid is our special precision coil-winding process. With maximum copper packed into the allowable space, each solenoid develops tremendous force for its size and power input. The low profile form, in addition to contributing to smaller size, permits maximum pole face surface area for the magnetic flux.

Another factor that contributes to high efficiency is the additional iron surface on the external portion of the plunger; it provides an auxiliary flux path and a significant increase in force.

The force is also affected by other interrelated features, such as the length of the iron path, the magnetic saturation properties of the solenoid case and plunger, and the area and shape of the pole pieces.

The enclosed construction of the solenoid not only provides an iron path with minimum losses at the ring gap, but also provides a rugged design for critical environment applications.

Conical Face: Higher force for longer strokes

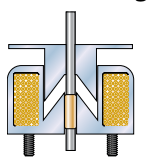

De-Energized

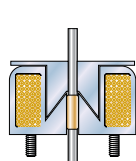

Energized

Flat Face: Higher efficiency for shorter strokes

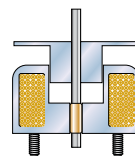

De-Energized

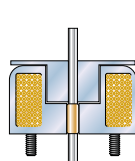

Energized

Call our application engineers at 937.454.2345 or [click here](#) for complete low profile solenoid specifications, performance data, dimensions, selection and ordering information

Design Considerations

Starting Force

When determining an application's force requirement, apply a 1.5 safety factor. For example: a load requiring 4.5 lb of force should utilize a solenoid providing 4.5 x 1.5 or 6.75 lb of force.

Duty Cycle

Duty cycle is determined by: ON time/(ON + OFF time).

For example: a solenoid is actuated for 30 seconds, then off for 90 seconds.
 $30 \text{ sec ON} / (30 \text{ Sec ON} + 90 \text{ sec OFF}) = 30/120 = 1/4 \text{ or } 25\% \text{ duty cycle.}$

Low Profile solenoids are rated for various duty cycles ranging from continuous to 10% duty. Note that maximum ON time for a particular application can be a factor which overrides the duty cycle rating.

Life

When selecting a Low Profile solenoid, as with any other solenoid style, it is important to consider factors that will affect the life of the unit. Heat, side-loading, stroke and operating environment all play an important role in determining the life you can expect in your application.

Power Requirements

Voltage applied to the solenoid must be matched to the coil wire size for proper operation. Solenoids are cataloged in coil awgs ranging from #23 up to #38 to accommodate your input power. Many other coil awg sizes are available. Please feel free to contact our application engineering department for availability.

Typical Examples of Custom Features

Even though many low profile models are in stock, our customers often require a product with unique features or performance capabilities. Please call to discuss your needs with one of our application engineers.

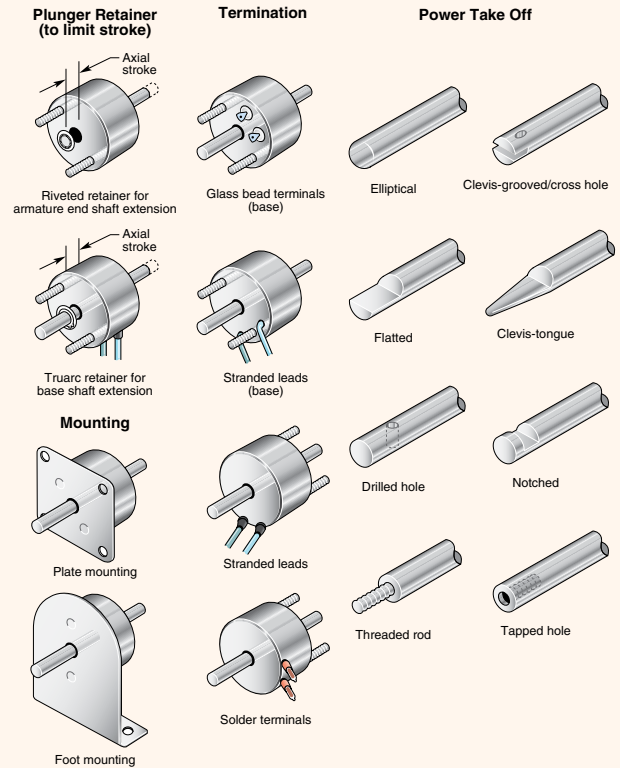

Low Profile Selection Overview

Size*	Package Dimensions		Max Stroke (in)	Nominal Stroke (in)	Force (lbs) @ Nominal Stroke at Specified Duty Cycle @ 20°C			
	Dia.	Length			100%	50%	25%	10%
OEC ●◆◆	0.750	0.500	0.150	0.060	0.19	0.44	0.94	2.06
1EC ●◆◆	1.000	0.530	0.240	0.080	0.25	0.50	1.25	3.20
2EF ●◆	1.125	0.580	0.075	0.030	2.00	3.50	7.00	13.50
2EC ●◆	1.125	0.580	0.240	0.100	0.25	1.00	2.00	3.75
3EF ◆	1.312	0.690	0.075	0.040	2.50	5.00	11.00	20.00
3EC ◆	1.312	0.690	0.300	0.120	0.80	2.00	3.80	5.60
4EF ◆	1.562	0.835	0.120	0.060	3.00	6.50	12.00	25.00
4EC ◆	1.562	0.835	0.250	0.150	1.00	2.25	5.50	11.50
5SF ◆	1.875	0.880	0.140	0.080	3.00	9.50	17.00	39.00
5EC	1.875	1.035	0.400	0.200	2.50	5.00	10.00	21.00
6SF	2.250	1.145	0.180	0.080	10.00	20.00	40.00	80.00
6EC	2.250	1.330	0.400	0.200	6.00	13.00	24.00	43.00
7EC	2.750	1.780	0.700	0.300	9.00	18.00	33.00	54.00
8EC	3.375	2.165	0.700	0.300	27.00	52.00	90.00	145.00

All data is at 20°C coil temperature. Force outputs degrade with elevated temperatures.

* EC sizes have conical face plungers; EF and SF sizes have flat face plungers.



Call our application engineers at 937.454.2345 or click here for complete Low Profile solenoid specifications, performance data, dimensions, selection and ordering information

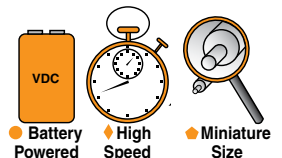

Ledex® Open Frame Solenoids

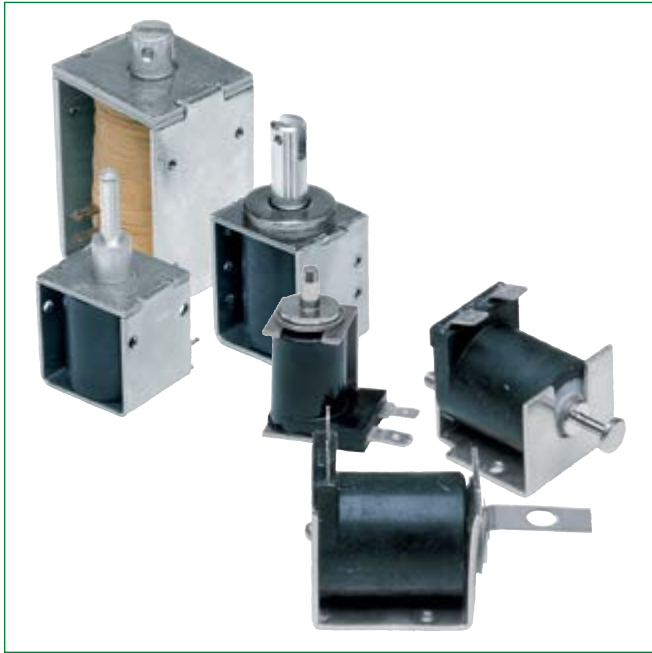

- Low cost, high volume products
- Selected Designs with Extremely long life operation
- Strokes to 1.00 inch
- Custom design work is our strength

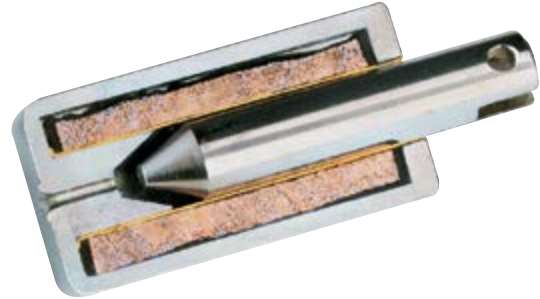

Principle of Operation

The open frame solenoid is the simplest solenoid device consisting of an open iron frame, an overmolded or taped coil, and a movable plunger in the center of the coil.

Open frame solenoids are designed with two frame styles, the C Frame style, in which the coil is enclosed on one side, and the Box Frame style in which the coil is enclosed on two sides. The Box Frame style provides slightly higher force output and is more rugged in design.

Tapped mounting holes are used for easy installation and interchangeability.

Most models have slotted and cross drilled plungers for easy load attachment.

The plunger is plated for corrosion resistance, and provides a low coefficient of friction and long life.

Over molded coils are available in both Box Frame and C Frame solenoids and offer excellent protection from moisture and humidity. Some solenoids are UL recognized. Most have UL recognized coil insulation systems.

Open frame solenoids are the most economical of all the solenoid types, and are typically selected for applications in which extremely long life and precise positioning are not critical.

Applications for Ledex® DC open frame devices are numerous. As with all types of solenoids, open frame models are well suited for applications which require either locking or latching functions.

Applications for DC open frame solenoids include residential and commercial door locks, credit card key "smart" locks, pharmaceutical compartment locks, circuit breakers, pinch valves, and many more.

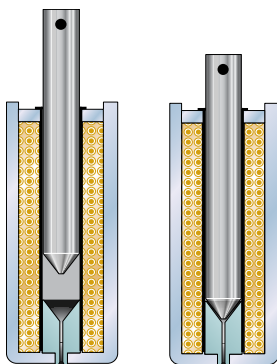

De-energized

Energized

Design Considerations

Starting Force

When determining an application's force requirement, apply a 1.3 to 1.5 safety factor. For example: when a 4.5 lb pull force is required, select a model with a safety factor of 1.3 to 1.5 times (5.8 to 6.7 lb).

Duty Cycle

Duty cycle is determined by solenoid ON time/(ON + OFF time).

For example: a solenoid is actuated for 30 seconds, then off for 90 seconds.

$30 \text{ sec ON} / (30 \text{ Sec ON} + 90 \text{ sec OFF}) = 30/120 = 1/4$ or 25% duty cycle.

Life

When selecting an open frame solenoid, as with any other solenoid style, it is important to consider the effects of heat, since an increase in coil temperature reduces the work output and the life of the unit. Life ratings extend to 5 million cycles depending on the product size and application. Consult the factory for longer life of 500,000 or more cycles, and other special requirements.

Frame Design Styles

DC actuated units are available in box frame and C frame design styles in a variety of models and sizes. Models are available for continuous use and intermittent duty. For low duty cycle applications, consider a magnetic latching open frame.

Box Frame

This solenoid has a 4-sided closed box frame and solid plunger and is, therefore,



more electrically efficient than the C Frame solenoid. The closed, box frame also provides improved mechanical strength.

C Frame

C Frame solenoids consist of a formed C-shaped steel frame and solid plunger. Therefore, these solenoids are less efficient and less costly than their Box Frame counterparts.



Open Frame Selection Overview

Size	Frame Type	Coil Type ⁽¹⁾	Height (in)	Width (in)	Length (in)	Max. Stroke (in)	Nominal Stroke (in)	Typical Force (lbs) Nominal Stroke ⁽²⁾ and 100% Rated Voltage @	
								100% Duty	25% Duty
B12 ●◆◆	Box	T	0.40	0.32	0.63	0.20	0.07	0.03	0.13
C5 ●◆◆	C	T	0.46	0.41	0.94	0.20	0.05	0.2	0.7
C5-L ●◆◆■	C - Latching	T	0.46	0.41	0.94	0.20	0.05	—	0.4
B17 ●◆◆	Box	T	0.59	0.51	0.79	0.18	0.05	0.2	0.6
B17-L ●◆◆■	Box - Latching	T	0.59	0.51	0.79	0.16	0.08	—	0.2
C8 ●◆	C	OM	0.81	0.75	1.13	0.50	0.25	0.05	0.3
C8-L ●◆■	C - Latching	OM	0.81	0.75	1.13	0.50	0.20	—	0.6
B20 ●	Box	T	0.94	0.81	1.14	0.50	0.25	0.1	0.4
B14 ●	Box	T	1.02	0.79	1.45	0.60	0.20	0.5	1.9
B14HD ●★	Box	T	1.02	0.79	1.45	0.60	0.20	0.5	1.9
B14-L ●■	Box - Latching	T	1.02	0.79	1.45	0.6	0.10	—	2
B28	Box	T	1.19	0.94	1.13	0.70	0.30	0.2	0.7
B28HD	Box	T	1.25	0.94	1.23	0.50	0.20	0.5	2.2
C26	C	OM	0.90	0.85	1.73	0.75	0.50	0.1	0.5
B75M ●	Box	T	1.14	1.00	1.63	0.60	0.20	1.1	3.4
B11HD	Box	T	1.25	0.94	2.00	0.70	0.40	1.3	3.0
B22	Box	OM	1.47	1.31	1.61	1.00	0.40	0.6	2.2
B22-L ■	Box - Latching	OM	1.47	1.31	1.61	0.35	0.10	—	3.3
B4HD	Box	OM	1.63	1.45	2.18	1.00	0.50	0.8	3.5
B41	Box	T	2.03	1.73	3.05	1.00	0.50	3.0	11.0

⁽¹⁾ OM = Overmolded; T = Taped ⁽²⁾ Using flat face plunger



Call our application engineers at 937.454.2345 or click here for complete open frame solenoid specifications, performance data, dimensions, selection and ordering information

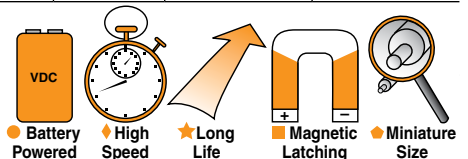

Looking for a Specialized Solution?



Johnson Electric offers an array of leading product brands and capabilities that span tooling and molds, micro motors, solenoids, actuators, precision gears, precision plastics, flexible circuits, switches and sensors.

- 50 years in electromechanical systems with a history in financial strength and long-term relationships with customers and supply chain partners
- Global operations provide local design, sales and support to customers 24/7
- High volume production lines
- Modular designs enabling simple, cost-effective modifications and subassembly solutions
- Customer-specific solutions-oriented with a high degree of flexibility
- Experienced teams of design and production engineers
- Excellent customer service and delivery performance with our technical design advantage
- Proven and reliable technology with an application focus that enables Johnson Electric to create best in class solutions
- Constantly leverage the benefits of scale and speed to ensure first mover advantage to our customers
- Unrelenting commitment to project success and to the ultimate attainment of zero defects in all areas of our business
- Robust project management process to ensure that collaboration with customers yields the fastest time to market

New Ledex® Innovations Tailored to Your Requirements

Ledex® Products is far and away the established leader in solenoid innovation, problem solving and product development for emerging market needs.

MagShift®, PMA™ and CamBolt™ exemplify new generation Ledex design concepts that are taking solenoid applications to a new level of performance.

Our goal with these and many engineered products is to make our customers increasingly competitive in a global market that is more and more demanding of new technologies and rapid advancements.



MagShift®

- Very low noise – sub 40 dBA power ON noise, including end-of-stroke stop
- Highly flexible, can change profiles and stroke with only a plunger adjustment
- Stops in mid-air, no end-stop required

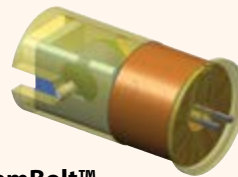

CamBolt™

- Bidirectional locking solenoid
- Highly resistant to shock and vibration
- Mechanically locks at each end of stroke with no power required
- 2 position linear device
- Can be battery powered
- Small size, short stroke



PMA™

- Magnetic latching, both extend and retract possible
- Long stroke
- Bidirectional latching options are easily tailored to user needs
- Non-magnetic external components – enables significant packaging flexibility for your application
- Separate high volume and low volume design constructions developed
- No screw machine or metallic components required
- Flexible design since case is not in flux path

	MagShift	CamBolt	PMA
Quiet Actuation	■		
Long Stroke			■
Magnetic Latching	■		■
Mechanical Latching		■	
Shock Resistance		■	
Bidirectional actuation		■	■
Medium to High Force	■		■



Call our application engineers at 937.454.2345 or click here for more information on these engineered products.

We look forward to putting any of these design concept products to work in your application. Please call to discuss your requirements.

The Simple Way to Make your Solenoid-Actuated Product Better and your Job Easier:

Value-Added Solenoid Subassemblies

Ledex® custom fabricated solenoids are designed, built, tested, packaged, and shipped to your exact specifications. Whether it's as simple as adding a special connector or mounting bracket, or fabricating a complete assembly, testing to confirm performance, and participating in your dock-to-stock inventory and delivery program, Ledex offers much more than "just solenoids".

Custom solenoid assemblies eliminate your added cost and trouble to maintain multiple vendors, added manufacturing resources and additional inventory. Typical modifications include: load interfaces, electrical connections and terminations, mounting adaptations, custom plungers, high temperature coils, shaft extensions, and specialized insulation such as UL approved systems or higher dielectric strength insulation.

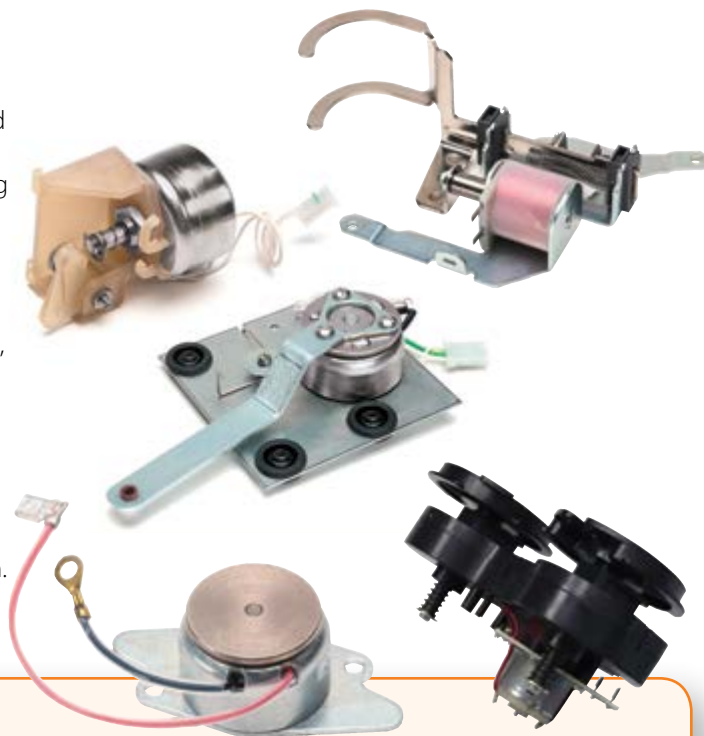

Value-Added Solenoid Example

We specialize in the design, engineering and production of custom subassemblies including solenoids, enclosures, mounting hardware, mechanical linkages, drive electronics and feedback sensors. The following example is typical of what we do to add value for our customers every day:

Customer Request:

Our customer had a demanding application for a complete solenoid subsystem including drive electronics, surge suppression, and a feedback sensor.

Our Solution:

We designed a complete system solution for the customer from concept to completion in a matter of weeks. Materials for this assembly include an STA tubular solenoid plus... bracket, adaptor, spring, hex nut, optical sensor, connector and cable, PCB, PC cable, actuator arm, stand-offs, trans. voltage suppression and housing. Completed units are tested, packaged, and shipped to the customer ready for immediate, easy installation.

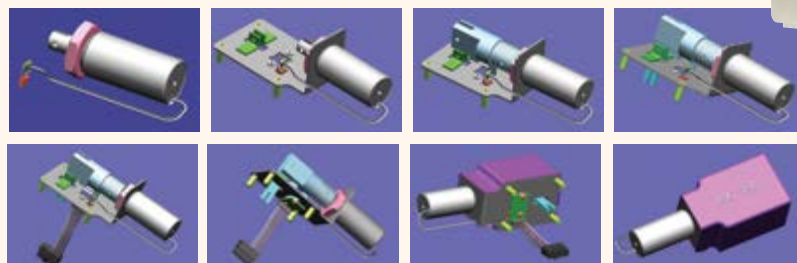

Headquarters

Johnson Electric Holdings Limited
Johnson Building, 6-22 Dai Shun St,
Tai Po Industrial Estate, New Territories
Hong Kong
Tel: +852 2663 6688
Fax: +852 2897 2054
e-mail: sales@johnsonelectric.com

Sales Offices

Asia

Shanghai, China

12/F, Hua Rong Tower
1289 Pudong Road South
Shanghai 200122 China
T +86 21 5882 2880
F +86 21 5882 2800

Shenzhen, China

2/F., Block 10,
Furong Industrial Estate
Xinqiao, Shajing, Baoan District
Shenzhen 518125 China
T +86 755 2990 0886
F +86 755 2990 0890

Japan

Keihin Higashi-Ohi Bldg.
10/F, 2-13-8 Higashi-Ohi
Shinagawa-ku, **Tokyo** 140-0011
T +81 3 5762 1031
F +81 3 5762 1032

Korea

6th Fl, Fine Bldg. 701-6
Banpo-Dong, Seocho-Ku
Seoul Korea 137-808
T +82 2 518 8347/8341
F +82 2 518 8342

Singapore

1 Maritime Square #09-02,
Harbour Front Centre
Singapore 048623
T +65 6224 7570
F +65 6224 4538

Europe

Austria

**Czech Republic, Hungary,
Slovakia, Slovenia**
Linzer Bundesstrasse 101
5023 **Salzburg**
T +43 662 88 4910
F +43 662 88 4910 11

France

10 Bld. Louise Michel
92230 **Gennevilliers**
T +33 1 46 88 07 70
F +33 1 46 88 07 99

Germany

**Denmark, Finland, Norway,
Sweden, Poland, Estonia,
Latvia, Lithuania, Russia**
Am Kreyenhof 10-12
26127 **Oldenburg**
T +49 441 3403 0
F +49 441 372 49

Italy

Via Cadamosto 3
20094 **Corsico** Milano
T +39 02 4869 21
F +39 02 4860 0692

Switzerland

Portugal, Spain, Turkey
Bahnhofstrasse 18
3280 **Murten**
T +41 26 672 71 11
F +41 26 670 19 83

The Netherlands / Belgium

Hanzeweg 12c
2803 MC **Gauda**
T +31 1825 43 154
F +31 1825 43 151

United Kingdom / Ireland

Johnson Electric International
(UK) Ltd
Unit 5, Woodstock Way,
Baldon Business Park
Baldon, Tyne & Wear
NE35 9PF United Kingdom
T +44 844 811 2130
F +44 844 811 2135

Americas

Connecticut, USA

10 Progress Drive
Shelton CT 06484
T +1 203 447 5362
F +1 203 447 5383

Ohio, USA

801 Scholz Drive
Vandalia OH 45377
T +1 937 454 2345
F +1 937 898 8624

Brazil

Av. Papa Joao Paulo i - 1174
Cumbica-Guarulhos - SP
07170-350 **Sao Paulo**
T +55 11 2431 5600
F +55 11 2432 4711